

# INSTALLATION INSTRUCTIONS

## EASYSTART SELECT



CONTROL UNIT FOR  
EBERSPÄCHER PARKING HEATERS



# CONTENTS

CHAPTER	CHAPTER TITLE	PAGE
	CHAPTER CONTENTS	
1	INTRODUCTION	
	Please read first	4
	Safety instructions	4
	Intended use	4
	General information	4
	– VENTILATION operating mode	4
	– Temperature sensor	4
	– Configuration	4
	Technical data	5
	Scope of supply	5
	Sketch of EasyStart Select scope of supply	6
2	INSTALLATION	
	Installing the EasyStart Select	7
	Installing the tab connector of the EasyStart Select lead harness	7
	EasyStart Select installation sketch	8
	Connector housing (Chamber assignment seen from the cable inlet side)	8
	-XS4 / -XB4 connector assignment table	9
	Installation sketch key	9
	Connection of bush housing to the control unit lead harness	9

# CONTENTS

3	STARTUP / CONFIGURATION	
	Initial startup	10
	Configuring the EasyStart Select	10
	Opening the vehicle workshop menu	10
	Selecting the settings for the standard configuration	11
	– Selecting the temperature units – Item 2:	11
	– Changing the preset operating time – Item 4:	11
	– Resetting to as-delivered condition – Item 5:	12
	– Functional check	12
4	WHAT TO DO IF ...?	
	Possible displays in the event of a fault	13
5	CIRCUIT DIAGRAM	
	– EasyStart Select connection to Hydronic, Hydronic II, Hydronic II C, Hydronic II Comfort, Hydronic M II	15
	– EasyStart Select connection to Airtronic, Airtronic M, Airtronic L	16
6	SERVICE	
	Technical Support	17

# 1 INTRODUCTION

## PLEASE READ FIRST

Before you start to install the EasyStart Select, always read through these installation instructions carefully.

These installation instructions contain important information, which you need to install the EasyStart Select.

## SAFETY INSTRUCTIONS



### DANGER!

Always note and follow all information and notes, especially the safety instructions in this document and in the heater's technical description!

## INTENDED USE

The EasyStart Select is used to select the operating mode, to set the operating time, and to switch On / Off the heater installed in the vehicle.



### PLEASE NOTE!

Improper use and use outside the specified purpose cancels all liability and warranty.

## GENERAL INFORMATION

### VENTILATION OPERATING MODE

In VENTILATION mode the fan of water heaters is actuated by directly bypassing heating mode. If the  symbol is not displayed the VENTILATION function is not available for the heater.

### TEMPERATURE SENSOR

The temperature sensor that is installed in the heater and which controls the temperature inside the vehicle is also used for the EasyStart Select temperature display.

### CONFIGURATION

These installation instructions describe the standard configuration. For details of enhanced configuration of the EasyStart Select and for special functions such as combinations with various EasyStart control units, refer to the "Special Functions and Diagnosis" Plus installation instructions. These are available in German and in English and can be viewed and downloaded from the Eberspächer Service Portal.

# 1 INTRODUCTION

## TECHNICAL DATA

Operating voltage	12 volt / 24 volt
Dimensions	W: 55 mm, H: 46 mm, D: 9 mm
allowable ambient temperature	– 40 °C to +85 °C
LCD ambient temperature	The display becomes sluggish in temperatures below –10 °C, i.e. the flashing sequence of the symbols is somewhat slower, the contrast becomes weaker above +70 °C.

## ORDER NO.

EasyStart Select 12 / 24 volt	22 1000 34 13 00
-------------------------------	------------------

## SCOPE OF SUPPLY

Sketch [see page 6](#).

No. in sketch	Quantity	Designation
1	1	EasyStart Select 12 / 24 volt
2	1	Cover
3	1	Foam underlay
4	1	Connector housing, 4-pin (in the bag)
5	1	Bush housing, 4-pin (in the bag)
6	2	Contact locking devices (in the bag)
7	4	Contacts (in the bag)
8	1	Self-tapping screws (in the bag)
9	1	Template
10	1	Installation instructions
11	1	Operating instructions

# 1 INTRODUCTION

## SKETCH OF EASYSTART SELECT SCOPE OF SUPPLY

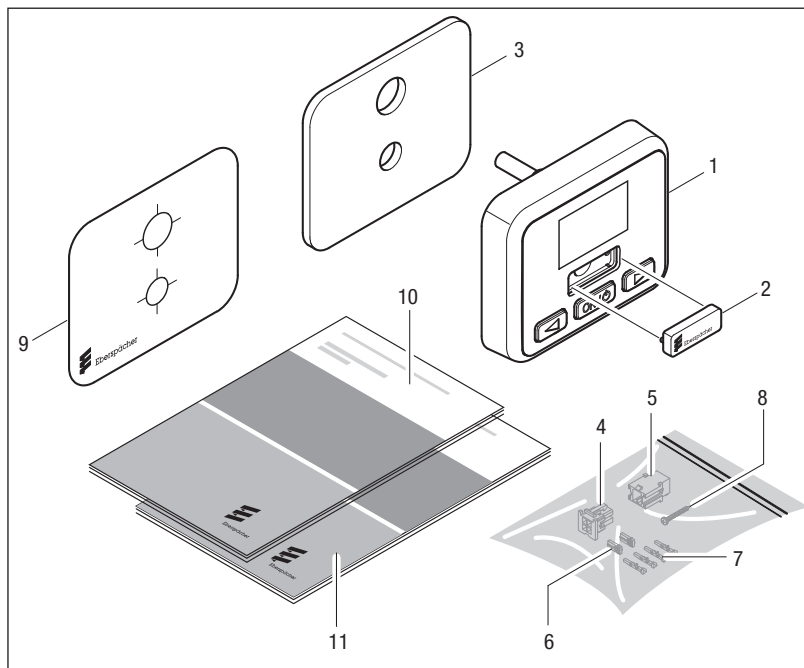

Key [see page 5](#)

## 2 INSTALLATION

### INSTALLING THE EASYSTART SELECT



#### CAUTION!

When drilling the fixing and connection holes in the dashboard, concealed components behind it could be damaged.

- ➔ Check that the space behind the installation area is free from components.

Install the EasyStart Select in a suitable place on the dashboard, within the driver's view and connect as shown in the sketch [on page 8](#) and the circuit diagram [from page 15](#).

- Use the template supplied to position and drill the two holes  $\varnothing 6.5$  mm and  $\varnothing 9$  mm.
- The foam underlay can be used if necessary to level out unevenness. To do this, pull off the protective film and stick the foam underlay onto the installation area. Then pull off the second protective film.
- Feed the lead harness from the EasyStart Select through the drillhole  $\varnothing 9$  mm.
- Insert the EasyStart Select with expansion plug into the drillhole  $\varnothing 6.5$  mm.
- Screw the fixing screw into the expansion plug and therefore fasten the EasyStart Select.

### INSTALLING THE TAB CONNECTOR OF THE EASYSTART SELECT LEAD HARNESS

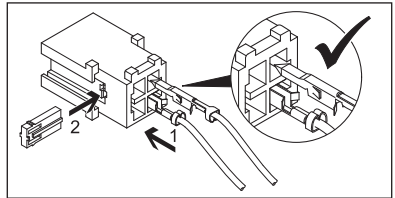

- Plug the tab connector of the EasyStart Select lead harness into the 4-pin connector housing (for details of connector housing pin assignment [see page 8](#) and [page 9](#)).
- Push the contact locking device into the connector housing.

#### PLEASE NOTE!

When installing the connector, ensure that the locking tangs always face the middle of the connector. Only in this position do the tangs latch into the housing (see sketch above).

## 2 INSTALLATION

### EASYSTART SELECT INSTALLATION SKETCH

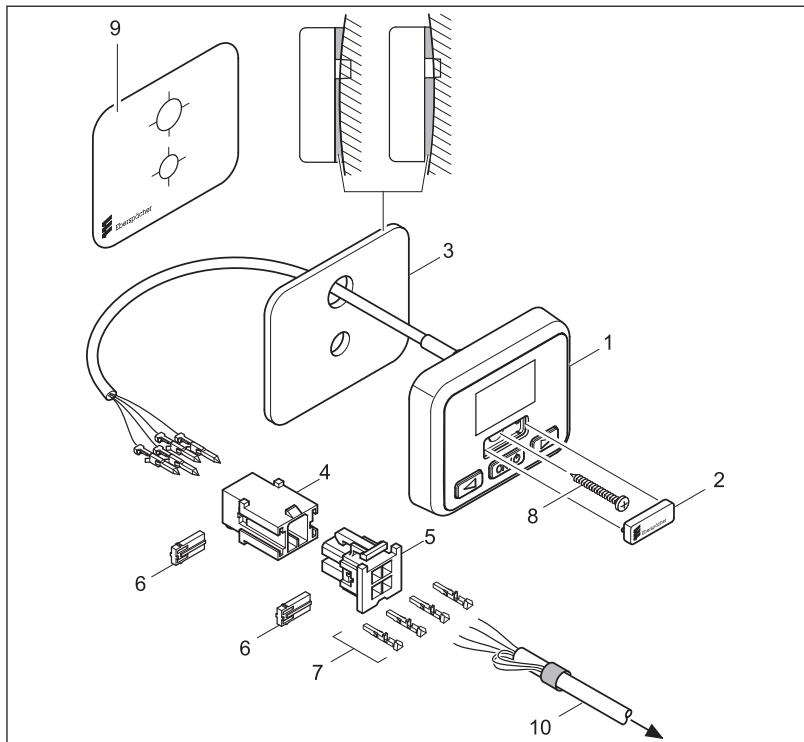

Key [see page 9](#)

### CONNECTOR HOUSING (Chamber assignment seen from the cable inlet side)

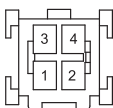

-XS4 (Item 4)

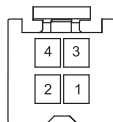

-XB4 (Item 5)



## 2 INSTALLATION

### -XS4 / -XB4 CONNECTOR ASSIGNMENT TABLE

Pin	Signal	Cable colour	Cross-section XS4	Cross-section XB4
1	Terminal 30	red	0.35 mm <sup>2</sup>	0.5 mm <sup>2</sup>
2	Terminal 58	grey / black	0.35 mm <sup>2</sup>	0.5 mm <sup>2</sup>
3	Terminal 31	brown	0.35 mm <sup>2</sup>	0.5 mm <sup>2</sup>
4	Diagnosis	blue / white	0.35 mm <sup>2</sup>	0.5 mm <sup>2</sup>

### INSTALLATION SKETCH KEY

- |    |                               |
|----|-------------------------------|
| 1  | EasyStart Select 12 / 24 volt |
| 2  | Cover                         |
| 3  | Foam underlay                 |
| 4  | Connector housing, 4 pin      |
| 5  | Bush housing, 4 pin           |
| 6  | Contact locking devices       |
| 7  | Contacts                      |
| 8  | Self-tapping screw            |
| 9  | Template                      |
| 10 | Heater lead harness           |

### CONNECTION OF BUSH HOUSING TO THE CONTROL UNIT LEAD HARNESS

- Clip the control unit lead harness into the 4-pin bush housing; note and follow the circuit diagram.
- Push the contact locking device into the bush connector housing.
- Connect the bush housing of the control unit lead harness and the connector housing of the EasyStart Select lead harness.
- Insulate and tie back any cable ends that are not needed.

#### PLEASE NOTE!

- Install the EasyStart Select in the vehicle interior only.
- For circuit diagrams see [from page 15](#).
- Do not insert the 5 A fuse into the fuse holder until all work has been completed.

## 3 STARTUP / CONFIGURATION

### INITIAL STARTUP

For the initial startup, the following steps must be carried out one after the other.

#### APPLYING THE OPERATING VOLTAGE

The operating voltage is applied by inserting the 5 A fuse into the fuse holder.

After applying the operating voltage the following display appears:

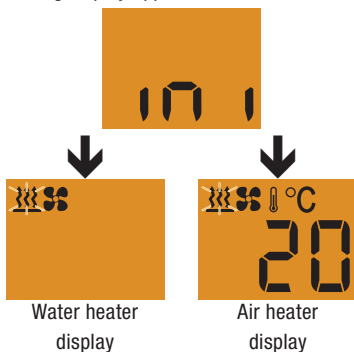

Note: The EasyStart Select checks which type of heater is connected and configures the Menu bar (automatic detection).

### CONFIGURING THE EASYSTART SELECT

The EasyStart Select must be configured according to its use.

#### PLEASE NOTE!

Note and follow the configuration information [on page 4](#).

### OPENING THE VEHICLE WORKSHOP MENU

Display ON, the Start display appears.



Start display  
water heater



Start display  
air heater

Press button and at the same time for longer than 5 sec.

The following display appears:





## 3 STARTUP / CONFIGURATION

### SELECTING THE SETTINGS FOR THE STANDARD CONFIGURATION



#### SELECTING THE TEMPERATURE UNITS – ITEM 2:

Default: °C

Use the  or  button to select Item 2: and confirm by pressing the  button.



Use the  or  button to select the temperature units °C or °F.



Use the  button to confirm the selection, then select the next setting or exit the Workshop menu with a LONGPRESS on the  button or via timeout.

#### CHANGING THE PRESET OPERATING TIME – ITEM 4:

Default: Water heater = 30 min. / Air heater = continuous heating mode

Use the  or  button to select Item 4: and confirm by pressing the  button.

Display for water heaters:





Operating time is 60 minutes.

Display for air heaters:





Operating time limitation OFF. Continuous operation is set.

Use the  or  button to set the operating time.

Operating time setting range:



10 – 120 min. in 1 min. increments, continuous heating mode is possible for air heaters. From the 120th min. the operating time can be extended in 5 min. increments up to 720 min.



Use the  button to confirm the selection, e.g. operating time 90 min., then select the next setting or exit the Workshop menu with a LONGPRESS on the  button or via timeout.

### 3 STARTUP / CONFIGURATION

RESETTING TO AS-DELIVERED CONDITION –  
ITEM 5:

Use the  or  button to select Item 5:  
and confirm by pressing the  button.



Press the  button to confirm the selection.

After confirming Item 5 appears briefly and then the following display.



Water heater  
display



Air heater  
display

Note: The EasyStart Select checks which type of heater is connected and configures the Menu bar (automatic detection).

FUNCTIONAL CHECK

Switch the heater On and Off. See EasyStart Select operating instructions. If an error or fault occurs, refer to the chapter “What to do if ...?” [page 13](#).

## 4 WHAT TO DO IF ...?

### POSSIBLE DISPLAYS IN THE EVENT OF A FAULT

#### DISPLAY

#### DESCRIPTION

#### REMEDY / WORKSHOP



- Automatic detection is active.
  - The EasyStart Select has been disconnected from the power supply and then reconnected.
- Wait until the automatic detection has finished.



- Heater fault
  - EasyStart Select fault
- Perform the diagnosis.
  - Check EasyStart Select, replace if necessary.

#### Note:

Display OFF with LONGPRESS on  button.



- Heater OFF - undervoltage applied.
- Charge the battery.
  - Check the voltage supply.

#### Note:

Display OFF with LONGPRESS on  button.



- No communication.
- Check and if necessary renew the heater fuse.
  - Check the voltage supply.
  - Check the wiring.



- Display if no diagnostic cable is connected.
- Connect diagnostic cable.

## 4 WHAT TO DO IF ...?

### DISPLAY

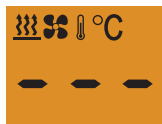

### DESCRIPTION

- Temperature sensor interruption.

### REMEDY / WORKSHOP

- Check and if necessary renew the temperature sensor.

## 5 CIRCUIT DIAGRAM

### CIRCUIT DIAGRAM

EasyStart Select connection to Hydronic, Hydronic II, Hydronic II C, Hydronic II Comfort, Hydronic M II

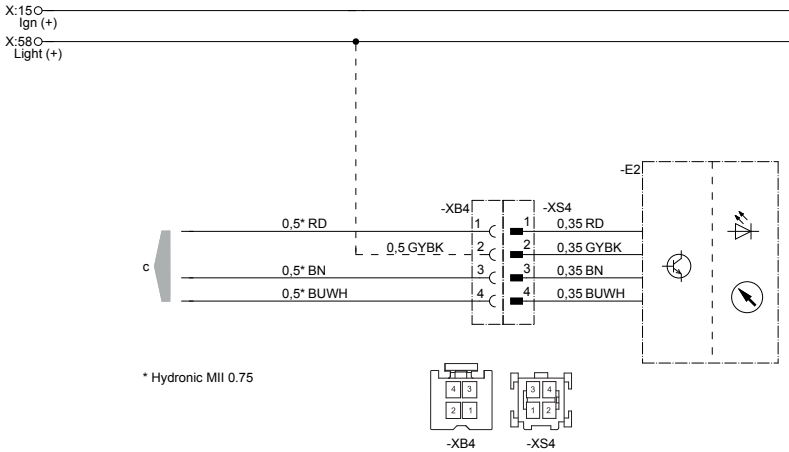

22 1000 34 97 34

-E2 EasyStart Select  
c to the heater

### CABLE COLOURS

RD	red	GY	grey	BK	black
BU	blue	YE	yellow	GN	green
WH	white	VT	violet	BN	brown

## 5 CIRCUIT DIAGRAM

### CIRCUIT DIAGRAM

EasyStart Select connection to Airtronic, Airtronic M, Airtronic L

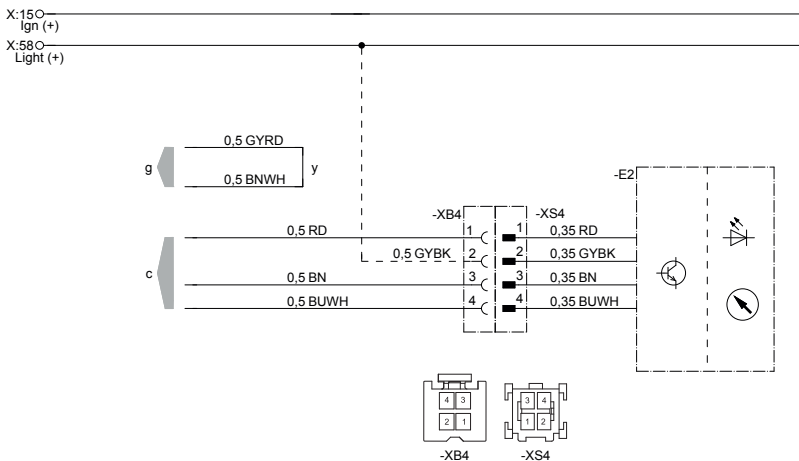

22 1000 34 97 35

-E2 EasyStart Select

c to the heater

g to the heater

y Connect cables and insulate

### CABLE COLOURS

RD	red	GY	grey	BK	black
BU	blue	YE	yellow	GN	green
WH	white	VT	violet	BN	brown



## 6 SERVICE

### **TECHNICAL SUPPORT**

If you have any technical questions or problems with the heater, the control unit or the operating software, please contact the following service address:

[support-UK@eberspaecher.com](mailto:support-UK@eberspaecher.com)

---





Eberspächer Climate Control Systems  
GmbH & Co. KG  
Eberspächerstraße 24  
73730 Esslingen  
Germany  
info@eberspaecher.com  
www.eberspaecher.com

