

THE POWER OF

REDARC®

THE MANAGER15

Battery Management System

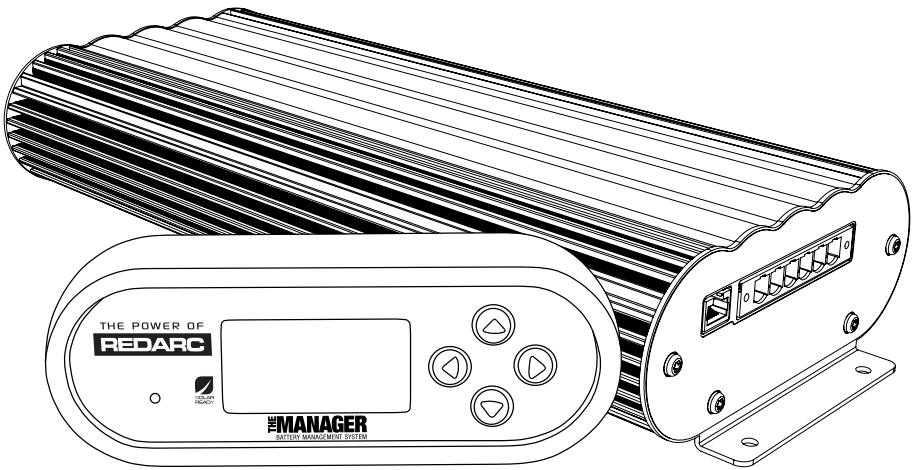

BMS1215S3



THE MANAGER15

The Manager15 Battery Management System is a complete charging solution for your Lead Acid Auxiliary or House battery. The system incorporates 12V Solar, 240V AC and 12/24V DC inputs to provide a 12V charging output at a maximum 15A rating.

The system also includes a Remote Monitor which provides information such as current, voltage and temperature as well as a simplified battery percentage and charge rate.

WARNINGS & SAFETY INSTRUCTIONS

SAVE THESE INSTRUCTIONS - This manual contains **IMPORTANT SAFETY INSTRUCTIONS** for The Manager15 battery management system.

DO NOT OPERATE THE BATTERY CHARGER UNLESS YOU HAVE READ AND UNDERSTOOD THIS MANUAL AND THE CHARGER IS INSTALLED AS PER THESE INSTALLATION INSTRUCTIONS. REDARC RECOMMENDS THAT THE CHARGER BE INSTALLED BY A SUITABLY QUALIFIED PERSON.

WARNING

1. RISK OF EXPLOSIVE GASES:

WORKING IN THE VICINITY OF A LEAD-ACID BATTERY IS DANGEROUS. BATTERIES GENERATE EXPLOSIVE GASES DURING NORMAL OPERATION. FOR THIS REASON, BATTERIES MUST BE CHARGED IN A WELL VENTILATED AREA. IT IS OF UTMOST IMPORTANCE THAT YOU FOLLOW THE INSTRUCTIONS EACH TIME YOU USE THE CHARGER.

2. THE AC POWER CONNECTION MUST BE CONNECTED TO AN EARTHED SOCKET OUTLET. DO NOT USE THE AC INPUT IF THE CORD IS DAMAGED. USE OF A NON-GENUINE OR DAMAGED AC INPUT CORD MAY RESULT IN A RISK OF FIRE, ELECTRIC SHOCK, OR INJURY TO PERSONS. (IF THE SUPPLY CORD IS DAMAGED, IT MUST BE REPLACED BY A SPECIAL CORD OR ASSEMBLY AVAILABLE FROM THE MANUFACTURER OR SERVICE AGENT).

CAUTION

1. The Battery Charger should not be used by persons (including children) with reduced physical, sensory or mental capabilities, or lack of experience and knowledge, unless they are supervised or have been instructed on how to use the appliance by a person responsible for their safety. Children should be supervised to ensure that they do not play with the Battery Charger.
2. Do NOT alter or disassemble the Battery Charger under any circumstances. All services or repairs must be returned to REDARC for repair. Incorrect handling or reassembly may result in a risk of electric shock or fire and may void the unit warranty.
3. Use of an attachment not recommended or sold by REDARC may result in a risk of fire, electric shock, or injury to persons.
4. Batteries are capable of providing very large currents in the case of a short circuit. A fuse must be installed on the positive wire outputs as close as practical to each battery. Failure to do so provides inadequate protection against fire in the case of a short circuit. The installer is responsible for ensuring that the correct cable and fuse sizes are used when installing this Battery Charger.
5. When charging a battery, make sure the settings at the Battery Setup menu on the Remote Monitor are correct for the type of battery under charge. Charging a battery with the wrong profile may cause the Battery Charger to indicate a fault or give misleading results and cause injury to persons, damage to the Battery Charger and/or property. Noticeable oscillations between Boost and Absorption stages indicate the wrong choice of battery type. Check and adjust battery type. If you are unsure of the battery type or settings to use, set to the Gel setting.
6. At hotter temperatures the current handling ability of a cable is reduced. Ensure cable diameter is increased when routing in hot areas such as the engine bay.

WARNINGS & SAFETY INSTRUCTIONS

7. Only use the Battery Charger for charging Standard Automotive Lead Acid, Calcium Content, Gel, AGM, SLI, or Deep Cycle type 12V batteries.
8. NEVER smoke or allow a spark or flame in vicinity of battery. This may cause the battery to explode.
9. Be extra cautious so as to reduce the risk of dropping a metal tool onto a vehicle battery. Doing so might cause the battery to spark or might short-circuit the battery or other electrical parts that may cause an explosion.
10. Remove personal metal items such as rings, bracelets, necklaces, and watches when working with a lead-acid battery. A lead-acid battery can produce a short-circuit current high enough to weld a ring or the like to metal, causing a severe burn.
11. **A SPARK NEAR A BATTERY MAY CAUSE THE BATTERY TO EXPLODE. TO REDUCE THE RISK OF A SPARK NEAR A BATTERY WHEN CONNECTING THE BATTERY INSTALLED IN A VEHICLE TO THE BATTERY CHARGER, ALWAYS DO THE FOLLOWING:**

Always wire the Output Connector before connecting it to the Battery Charger. During connection of the unit, the Battery Output (positive) must be connected first, followed by the Ground (chassis) terminal. The chassis connection should be made away from the battery and fuel lines. DC Input (positive) should be connected last. Once all connections are wired to the Output Connector, plug the connector into the Main Unit.

When disconnecting the Battery Charger, remove the AC Connector first, followed by the CAN connection then the Output Connector from the Main Unit. The DC Input should be disconnected next, followed by the Ground (chassis) connection, then the Battery Output connection if complete removal is necessary.

12. PERSONAL SAFETY PRECAUTIONS

To assist with the safe operation and use of the Battery Charger:

- a) Consider having someone close by to come to your aid when you are using the Battery Charger.
- b) Have plenty of fresh water and soap nearby in case battery acid contacts skin, clothing, or eyes.
- c) Wear complete eye protection and clothing protection. Avoid touching eyes while working near a battery.
- d) If battery acid contacts your skin or clothing, remove the affected clothing and wash the affected area of your skin immediately with soap and water. If battery acid enters your eye, immediately flood the eye with running cold water for at least 10 minutes and seek medical assistance immediately.
- e) To improve user safety it is recommended to control the charger and monitor the charging process using the remote away from the vicinity of the battery being charged.

NOTICE

1. Do NOT connect computers or IT equipment to the Charger front panel connector or remote. Damage may occur.
2. It is recommended to leave the remote connected at all times to the base unit.
3. The Main Unit must be fixed using suitable screw mounts. Failure to adequately mount the unit, such as using adhesives to mount the unit will result in unreliable operation of the charger.
4. When using the charger in Storage mode, make sure that all loads are disconnected from the house battery under charge. Failure to do so may cause the house battery to be under charged, give false readings on the State of Charge indicator and possibly cause damage to any loads connected.
5. A partially shaded panel (or low-light conditions such as dawn or dusk) will increase the target solar panel voltage level to match the maximum power point. In this situation solar will be selected as a source however little or no current will be flowing into the battery.
6. Modification of the 'Advanced Settings' menu items affect the way the Battery Charger responds to charging situations. Modification of these settings may result in the Battery Charger not functioning at 100% of its capacity. These settings should only be modified if absolutely necessary and when the effects of the changes are 100% understood.
7. Touring mode will achieve it's best charge level if a Storage mode charge has been recently performed.
8. It is the installers responsibility to ensure their installation complies with any applicable legal and regulatory requirements. Within Australia, installers may wish to consult AS/NZS 3001 as one potentially relevant standard. For installation in caravans and similar vehicles, the connection to the supply mains is to be in accordance with the national wiring rules.

CONTENTS

Table of Contents	Page
Warnings and Safety Instructions	01
Contents	03
Features and Benefits	04
1 Introduction	05
1. General Description	05
2. The Remote Monitor	05
3. The Kit Includes	05
4. Specifications	06
5. Multi-stage Charging Process	08
6. Maximum Charging Current Setting	10
7. Green Power Priority	10
2 INSTALLATION Guide	11
1. System Layout	11
2. Mounting Instructions	11
1. Mounting the Main Unit	12
2. Mounting the Remote Monitor	13
3. Mounting the Battery Sensor	16
3. DC Cable Size Requirements	16
4. The Manager15 Wiring Connections	18
1. Load Disconnect Feature	18
2. Ignition Trigger Feature	18
3. Connecting the Battery Sensor	19
4. Wiring the Main Unit	19
5. Batteries	21
6. MPPT Solar Regulator	22
3 USER Guide	23
1. Remote Monitor	23
2. Understanding the Display	23
3. Initial Setup	24
4. User Menu	25
5. Settings Menu	27
6. Fault Screens	31
7. Troubleshooting	32
8. Factory Settings	34
9. FAQs	35
4 Remote Drill Template	36
5 Two Year Warranty	38

FEATURES AND BENEFITS

1. The Manager15 incorporates six products in one, it's a DC-DC charger, a 240-volt charger, a solar charger, a dual battery isolator, a load disconnect controller and a remote battery monitor. The Manager15 will automatically select between charging sources, requiring no input from the operator during its operation.
2. The Manager15 has no fan or mechanical relays, which makes it SUPER quiet and very reliable.
3. The Manager15 is designed and manufactured in Australia, for Australian conditions, using the latest electronic and design technologies. It is manufactured with high-quality components to ISO9001 quality and ISO14001 environmental standards and backed with REDARC's quality service and two-year warranty.
4. The Manager15 charging algorithm uses solar whenever possible making the unit more energy efficient and better for the environment.
5. The Manager15's DC-DC charging enables optimal charging of house batteries, even if they have different chemical characteristics from the vehicle battery. The input voltage can be above, equal to or below the output voltage.
6. State of Charge (SOC) indication means you will always know how fully charged the battery is and how much longer it will need to achieve full charge. An easy to operate, high-quality, user friendly graphical display module lets you know what's going on at all times.
7. The Manager15 is very reliable and includes reverse polarity protection (without depending on fuses) and short circuit protection. The unit has undergone stringent safety & electrical compliance testing.
8. The Manager15's easily selectable charging profiles make it suitable for charging all lead-acid battery types commonly used in modern caravans and motorhomes.
9. The Manager15 disconnects automatically from the vehicle battery, so there is always power to start the car.
10. Sophisticated fault detection monitors the house battery condition during all stages of charging, keeping you and your caravan/ camper/ RV safe.
11. The Manager15 has a separate battery sensor to monitor battery conditions and state of charge even while The Manager15 is in standby mode. The battery sensor monitors current, voltage and temperature of the house batteries.
12. Automatic temperature and voltage drop compensation.

1 INTRODUCTION

1.1 General Description

The Manager15 is designed to offer a complete solution to battery charging and maintenance needs for recreational automotive applications.

The Manager15 incorporates AC, DC and Solar inputs to achieve the best charge to a house battery.

1.2 The Remote Monitor

The Manager15 comes with a Remote Monitor designed to give you house battery information and charge status along with critical system information while charging is in progress.

With the Remote Monitor, you can customise how your house battery is charged and monitor where the charge is coming from, keeping you in control at all times.

The Remote Monitor can be surface mounted on a wall, or recessed (into the dashboard of an RV for example).

1.3 The Kit Includes

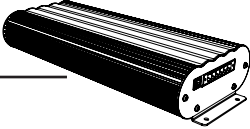
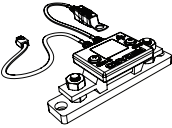
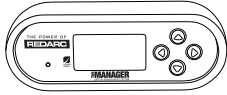
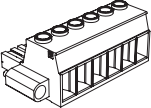
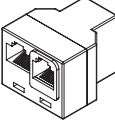
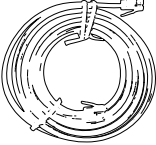
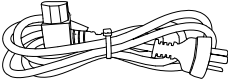
- 1 Main Unit 
- 2 Battery Sensor 
- 3 Remote Monitor 
- 4 Output Connector 
- 5 T-Piece (RJ45 with RJ12 insert) 
- 6 CANBus Cables (1m & 5m) 
- 7 Power Cable 



2009/19/EC adapting to Council Directive 72/245/EEC relating to radio interference (electromagnetic Compatibility) of vehicles, clauses 6.5, 6.6, 6.8 & 6.9 only.
2004/104/EC: 14th October 2004 adapting to technical progress of Council Directive 72/245/EEC relating to radio interference (electromagnetic compatibility) of vehicles.
IEC 60335-2-29:2002 (Fourth edition) + A1:2004 + A2:2009 in conjunction with IEC 60335-1:2010 (Fifth edition) +A1:2013
EN 60335-2-29:2004 + A2:2010
EN 60335-1:2012+A11:2014
AS/NZS 60335.2.29: 2004 + A1 + A2
AS/NZS 60335.1: 2011 + A1+ A2 + A3

1.4 Specifications

Electrical Specifications

Inputs

AC Input

Input Voltage Range (nominal)	220-240VAC 50Hz
Power Rating	280W
Efficiency	80% - 90%
Connection	IEC Mains Plug

DC Input

Input Voltage Range	9 - 32V
Maximum Input Current Rating	30A
Turn ON/OFF Threshold 12V (24V)	13.2V/12.7V (26.4V/25.4V)
Power Rating	260W
Typical Efficiency	94%
Connection	Phoenix 1967498 Connector

Solar Input

Input Voltage Range	9 - 32V
Maximum Input Current Rating	30A
Turn ON (Open Circuit Voltage)	17.5V
Power Rating	260W
Typical Efficiency	93%
Connection	Phoenix 1967498 Connector

Max Charging Volts @ Battery Terminals

	Storage Mode	Touring Mode
Gel Setting	14.4V	14.4V
AGM Setting	14.4V	14.4V
Calcium Setting	16.0V	15.2V
Standard Lead Acid Setting	15.5V	14.8V
Float Voltage	13.5V	13.5V
Output Current (Nominal)	15A	
Temperature Compensation	-30mV / °C	
Unit Operating Temperature*	-40°C - 80°C	
Over Temperature Shutdown	Yes	
Total Battery Capacity	40 - 800Ah	
Output Battery Volts (Nominal)	12V	
Output Battery Volts (Minimum)	4V	
Maximum Current on Load Disconnect Wire	1A	
Memory Save on Battery Disconnect	Yes	
Output Protection		
Short Circuit Protection	Yes	
Surge Protection	Yes	
Reverse Polarity Protection	Yes	
Overload Protection	Yes	
Compliance		
CE	2009/19/EC	
	2009/104/EC	
Safety	IEC60335	
Environmental	RoHS Compliant	
General Specifications		
Main Unit Dimensions	445x185x79mm	
Remote Dimensions	186x74x29mm	
Kit Weight	5.5kg	
Warranty	2 years	

* The Manager15 will only charge the battery when the **battery temperature** is between 0°C and 60°C in order to protect the battery from damage.

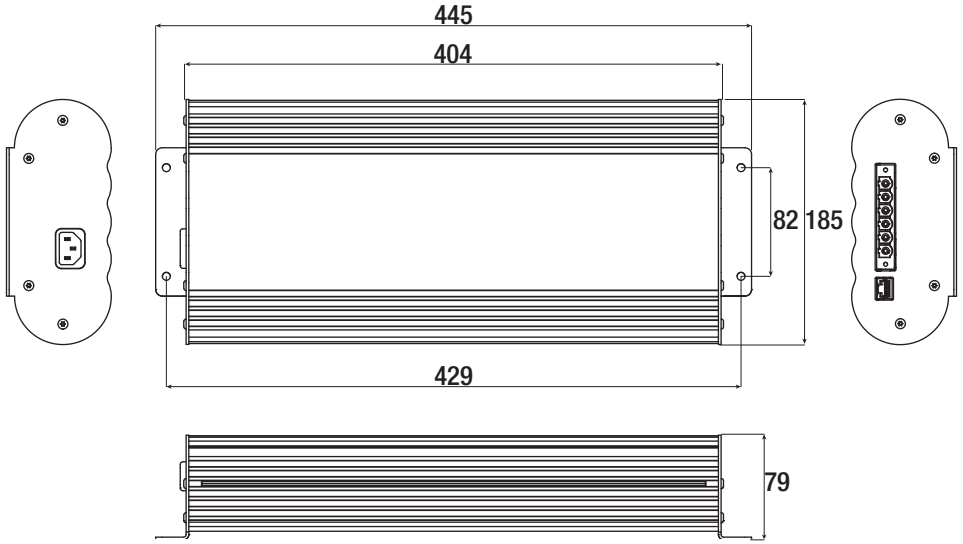

Figure 1.4.1 - Main Unit Dimensions

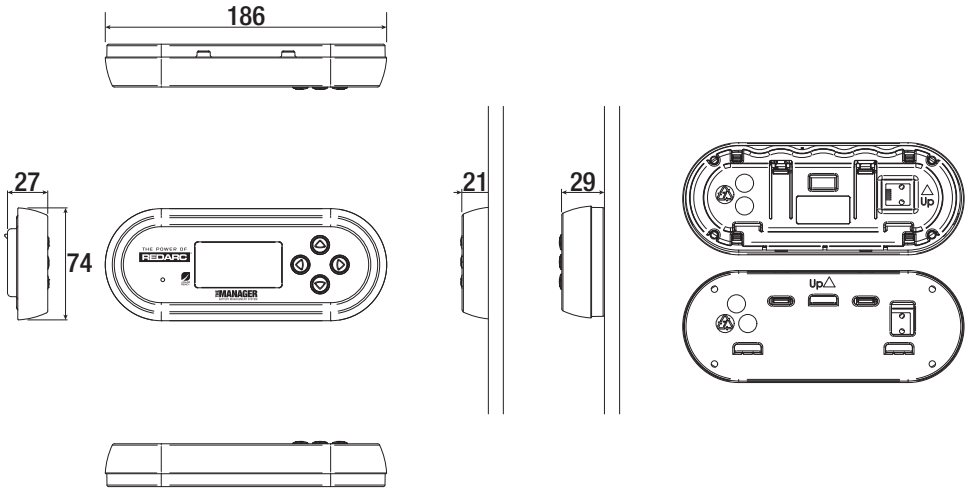

Figure 1.4.2 - Remote Monitor Dimensions

1.5 Multi-stage Charging Process

The Manager15 incorporates two different multi-stage charging profiles – Touring (3-stage) and Storage (8-stage) – which can be selected in the Battery Mode menu on the Remote Monitor.

Touring Mode

Touring mode is designed for use when ‘on the road’. Touring mode offers a 3-stage charging profile consisting of Boost, Absorption and Float stages (see Figure 1.4.1). In Touring mode, the house battery is monitored to detect only a limited number of faults such as short circuit, over current and over voltage. This allows The Manager15 to operate correctly even when loads are connected to the house battery. This mode will always produce an output (unless a fault condition is detected) and will cycle through the three stages as required to maintain the house battery as outlined in Figure 1.4.1.

NOTICE

Touring mode will achieve its best charge level if a Storage mode charge has been recently performed.

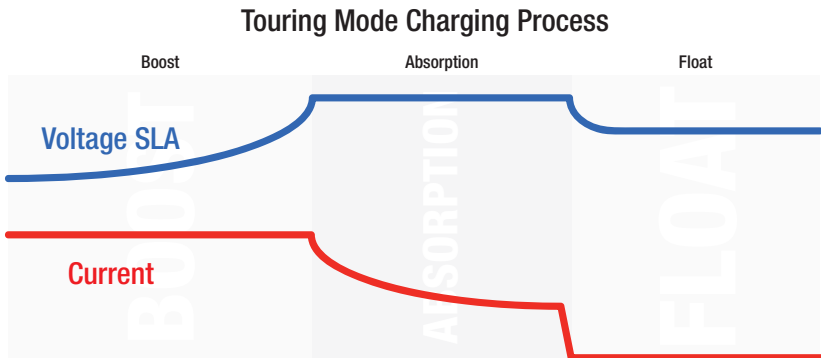

Figure 1.4.1 - Touring Mode Charging Process

Storage Mode

Storage mode is designed to charge the house battery to its optimal level and maintain that level while your caravan is in storage. This mode requires all loads to be switched off or disconnected from the house battery before charging. It uses a 8-stage charging profile consisting of Desulphation, Soft Start, Boost, Absorption, Battery Test, Equalise, Float and Maintenance stages (see Figure 1.4.2). Storage mode is designed to detect a wide range of battery fault conditions, for more information on these fault conditions, please refer to the Troubleshooting section of this manual. Unlike Touring mode, Storage mode does not cycle. This means that when the charging process is completed, The Manager15 will always remain in either Float or Maintenance stages. Float stage will provide the house battery with a 'trickle' charge whenever the house battery voltage drops below a predetermined threshold to ensure the battery stays charged. Maintenance stage turns The Manager15 output off, but continues to monitor the house battery and will revert to Float stage when necessary.

NOTE: If The Manager15 is set to Storage mode and the vehicle is started The Manager15 will automatically switch to Touring mode once it senses an increase in input voltage from the alternator.

NOTICE

When using the charger in Storage mode, make sure that all loads are disconnected from the house battery under charge. Failure to do so may cause the house battery to be under charged, give false readings on the State of Charge indicator and possibly cause damage to any loads connected.

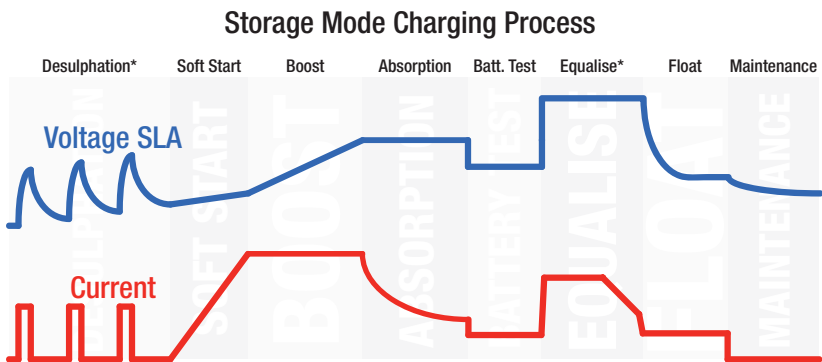

Figure 1.4.2 - Storage Mode Charging Process

IMPORTANT

When The Manager15 is set to 'Storage' mode and no valid charging sources are connected, it will enter a 'Sleep' mode 30 seconds after the last user interaction. The sleep mode is designed to limit the amount of current drawn from the output battery by the system whilst in Storage mode and does this by switching the screen and all non-essential functions off. The Manager15 will 'wake-up' from its Sleep mode if a button is pushed or if any valid input source is sensed, though this may take 30-60 seconds to occur after the source is connected.

1.6 Maximum Charge Current Setting

The Manager15 allows the user to set the maximum charge current for their battery, making it suitable for charging batteries as small as 40Ah in capacity. When the charge current is set below the maximum 15Amps, the current supplied to charge the battery is restricted to the user setting. Any excess current is used to power loads running from the battery under charge.

If no loads are running from the battery, total current from The Manager15 will be restricted to the level set by the user.

1.7 Green Power Priority

The Manager15 is designed to charge from multiple sources simultaneously to charge the auxiliary/house battery. If the Solar power input is available the maximum available solar power will be used before topping up the output charging current from another source if available (e.g. mains). Priority is given to Solar then to AC Mains power, then to DC Vehicle power.

2 INSTALLATION GUIDE

2.1 System Layout

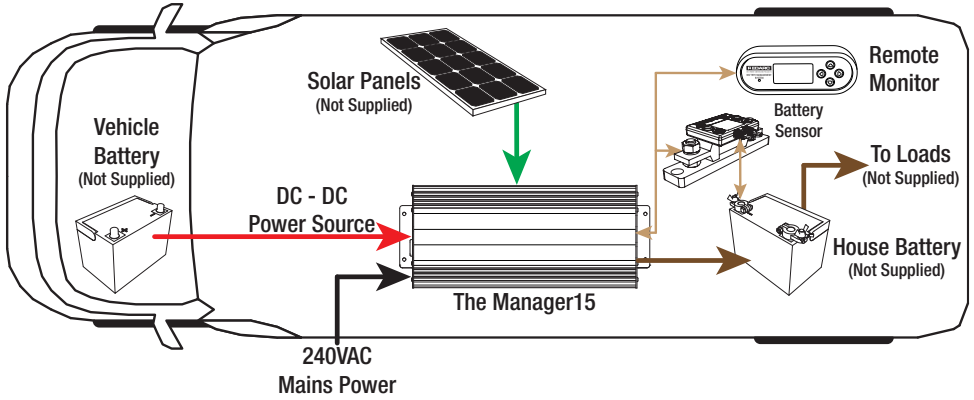

Figure 2.1.1 - System Layout

2.2 Mounting Instructions

This section describes how to mount the three major components of The Manager15: the Main Unit, the Remote Monitor and the Battery Sensor.

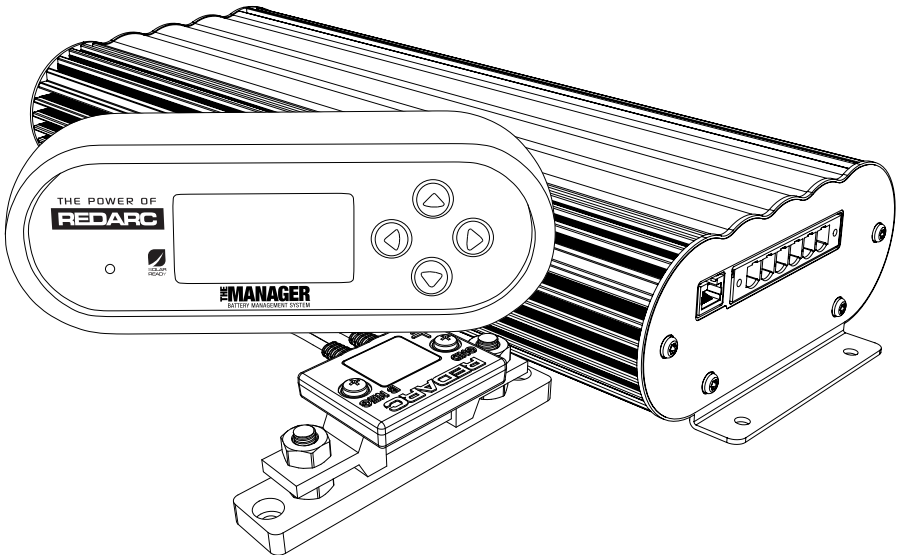

Figure 2.2.1 - The Manager15 System

2.2.1 Mounting the Main Unit

Do NOT expose the Main Unit to rain, snow, spray or bilge water. For optimum operation, The Manager15 should be mounted where the temperature is nominally below 35°C and does not exceed a maximum of 60°C.

The Main Unit must not be installed in a location with any less than 10cm clearance at the top of the Main Unit, to allow for airflow across the heatsink fins. The Main Unit should be installed as close as possible to the house battery.

The Main Unit must be mounted to a flat, solid support using M6 sized screws or bolts, using all four mounting holes.

NOTICE

The Main Unit must be fixed using suitable screw mounts. Failure to adequately mount the unit, such as using adhesives to mount the unit will result in unreliable operation of the charger.

REDARC recommends that the Main Unit be mounted to optimise airflow past the heatsink. Mounting the unit horizontally (see Figure 2.2.1.1) is recommended and mounting vertically (see Figure 2.2.1.2) is still acceptable. Do NOT mount the unit as shown in Figure 2.2.1.3.

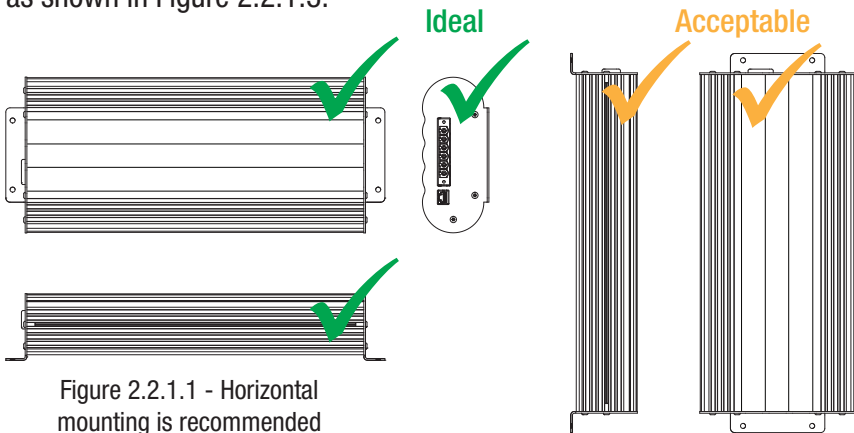

Figure 2.2.1.1 - Horizontal mounting is recommended

Figure 2.2.1.2 - Vertical mounting is acceptable



Figure 2.2.1.3 - Do NOT mount the unit upside down

2.2.2 Mounting the Remote Monitor

The Remote Monitor should be mounted inside the caravan or RV using the template provided inside the box. It is acceptable however to mount the Remote Monitor in any convenient location, as long as it is protected from harsh environments.

Figures 2.2.2.1 and 2.2.2.2 illustrate how to recess and wall mount the Remote Monitor unit, figure 2.2.2.3 illustrates removal of the Remote Monitor.

Recess

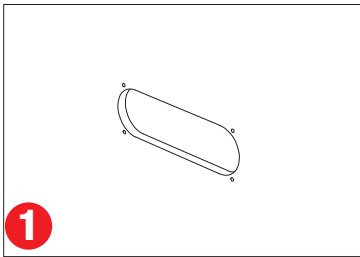

1 Use the template provided (Page 36) to mark the position and drill and cut the mounting holes into the wall.

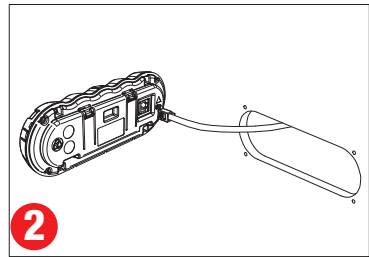

2 Feed the Remote Monitor cable through the hole and connect it to the Remote Monitor.

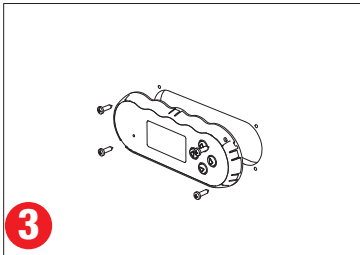

3 Mount the Inner Assembly to the wall using 4 suitably sized screws.

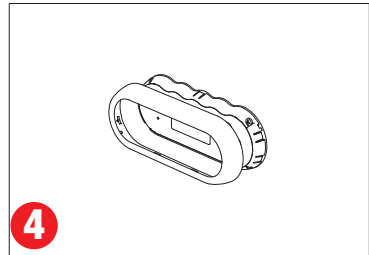

4 Clip the Front Face to the Inner Assembly.

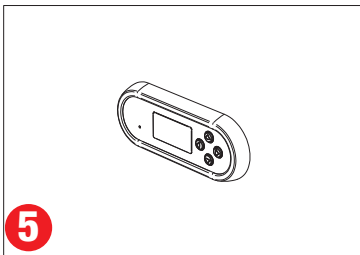
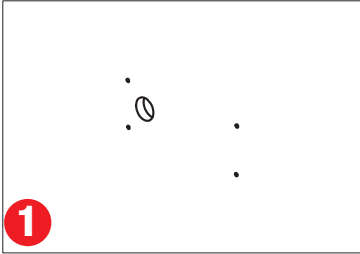
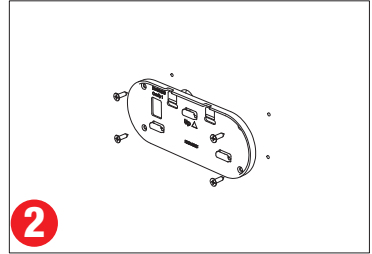

Figure 2.2.2.1 - How to recess the Remote Monitor into the wall.

Wall Mount



1 Use the template provided (Page 36) to mark the position and drill and cut the mounting holes into the wall.



2 Attach the Back Plate to the wall using 4 suitably sized countersunk screws.

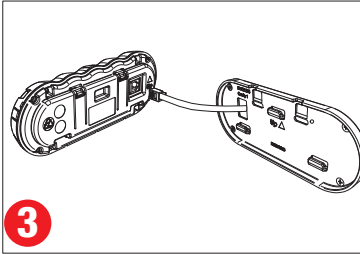

3 Feed the Remote Monitor cable through the hole and connect it to the Remote Monitor.

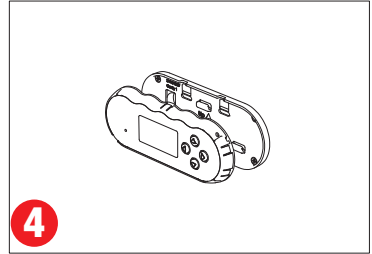

4 Clip the Inner Assembly into the Back Plate.

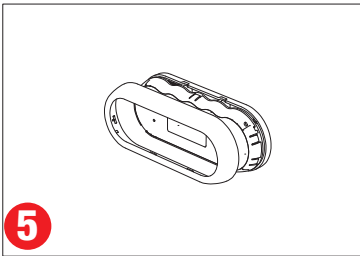

5 Clip the Front Face to the Inner Assembly.

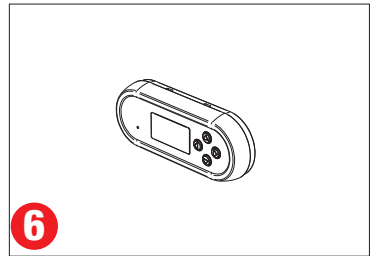

6

Figure 2.2.2.2 - How to wall mount the Remote Monitor.

Removing the Remote Monitor

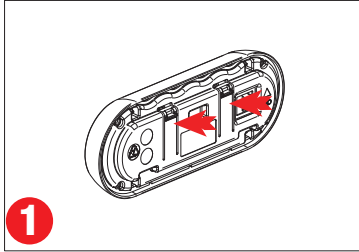

1 The locking tabs on the back of the Inner Assembly need to be unclipped from the Back Plate.

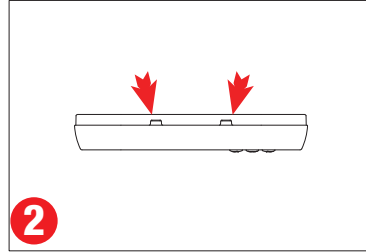

2 The locking tabs can be accessed through holes on the top of the backing plate when installed.

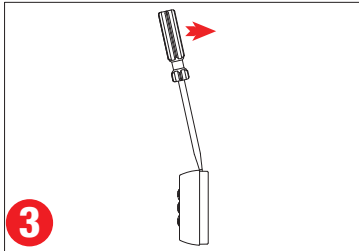

3 Insert a flat-head screwdriver at a slight angle towards the front of the Remote Monitor and push back to depress the locking tabs.

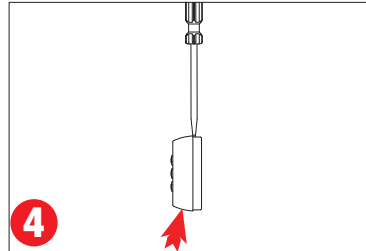

4 When the screwdriver is in a vertical position, gently push upwards on the bottom of the Remote Assembly to unlock tab. Repeat 3 & 4 for 2nd tab.

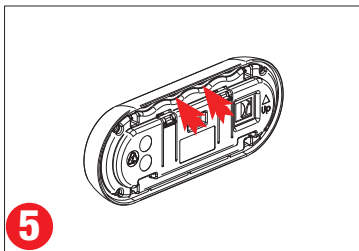

5 Slide fingers between the Front Face and the Inner Assembly in positions marked above and carefully pull back towards the front of the Remote Monitor.

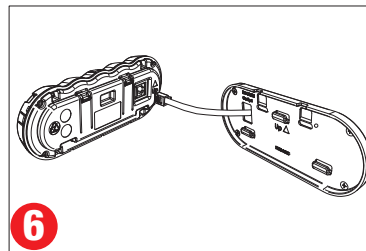

6 Remove the Remote Monitor cable and the Inner Assembly is removed.

Figure 2.2.2.3 - How to remove the Remote Monitor.

2.2.3 Mounting the Battery Sensor

The length of cables on the Battery Sensor to connect to the Main Unit and the House Battery will dictate the allowable mounting distance from the battery.

The Battery Sensor should be mounted to a solid surface using two suitably sized screws for attachment.

Figure 2.2.3.1 illustrates how to mount the Battery Sensor.

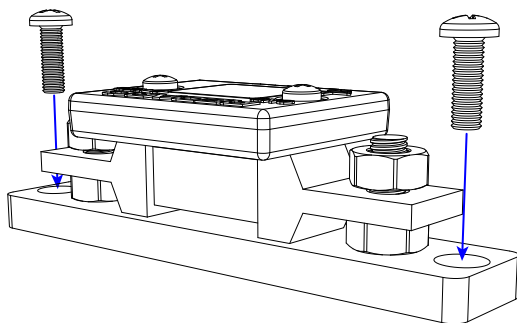

Figure 2.2.3.1 - Mounting the Battery Sensor

2.3 DC Cable Size Requirements

⚠ CAUTION

Batteries are capable of providing very large currents in the case of a short circuit. A fuse must be installed on the positive wire outputs as close as practical to each battery. Failure to do so provides inadequate protection against fire in the case of a short circuit. The installer is responsible for ensuring that the correct cable and fuse sizes are used when installing this Battery Charger.

The Manager15 is capable of drawing up to 30A from the Vehicle Battery (which may be several metres from its installation location) and is limited to 15A output to the House Battery.

Prior to installation:

- DC input and output cables should be as short as possible (preferably no longer than the values shown in table 2.3.1 & 2.3.2)
- The size of the cable should be thick enough to maintain a voltage drop of less than 3% when carrying the maximum input current. This will help prevent frequent low-input voltage warnings, shutdown and poor charging performance. The Manager15 will operate with less efficient cabling however for best performance, high-quality cable connections should be used to minimise voltage drop and efficiency losses
- The following sizes of cables and fuses are recommended for connection of the DC cables batteries to Manager15, see table 2.3.1 & 2.3.2 over the page for suitable cable sizing for your installation.

2.3.1 Input Wire Diameter Selection

REDARC recommends the installer use cabling and connections between 8B&S and 6B&S automotive. REDARC recommends that the input wire be of the size outlined in Table 2.3.1.

Distance from input to The Manager15	Recommended Cross Sectional Area (mm ²)	Recommended Diameter Equivalent	Recommended Fuse Size
≤3m	8	8 B&S	40A
3 - 5m	13	6 B&S	
5 - 8m	21	4 B&S	

Figure 2.3.1 - Recommended input cable size

⚠ CAUTION

At hotter temperatures the current handling ability of a cable is reduced. Ensure cable diameter is increased when routing in hot areas such as the engine bay.

As a guide, when routing in hot areas such as the engine bay, move to the next cable diameter size in figure 2.3.1, i.e. for an engine bay install of less than 3m in cable length, upgrade the cable from 8mm² to 13mm².

2.3.2 Output Wire Diameter Selection

REDARC recommends the installer use cabling and connections between 8B&S and 6B&S automotive. REDARC recommends that the output wire be of the size outlined in Table 2.3.2. For longer runs using 10mm² is recommended (the recommended maximum length is 5m).

Distance from The Manager15 to House battery	Recommended Cross Sectional Area (mm ²)	Recommended Diameter Equivalent	Recommended Fuse Size
≤2m	4	6mm AUTO or 10 B&S	20A or 23A
2 - 3m	6	10 B&S	
3 - 5m	10	6 B&S	

Figure 2.3.2 - Recommended output cable size

2.4 The Manager15 Wiring Connections

⚠ WARNING

REDARC recommends that this unit be installed by a suitably qualified person.

⚠ WARNING

The AC power connection must be connected to an earthed socket outlet. Do not use The Manager15 AC input if the cord is damaged. Use of a non-genuine or damaged AC input cord may result in a risk of fire, electric shock, or injury to persons. (If the supply cord is damaged, it must be replaced by a special cord or assembly available from the manufacturer or service agent).

⚠ CAUTION

Always wire the Output Connector before connecting it to the Main Unit. During connection of the unit, the Battery Output (positive) must be connected first, followed by the Ground (chassis) terminal. The chassis connection should be made away from the battery and fuel lines. DC Input (positive) should be connected last. Once all connections are wired to the Output Connector, plug the connector into the Main Unit.

When disconnecting remove the Output Connector from the Main Unit first. The DC Input should be disconnected next, followed by the Ground (chassis) connection, then the Battery Output connection.

2.4.1 Load Disconnect Feature

The Load Disconnect wire is a ground switch to activate a relay for disconnection of any loads running from the house battery. The relay must be 12V with a maximum coil current of 1A and resistor or diode suppression is recommended. The Load Disconnect feature must be activated in the User Menu as explained in section 3.3 of this manual.

2.4.2 Ignition Trigger Feature

The Ignition Trigger wire is used to turn the DC charging source on with ignition. In most circumstances this wire does not need to be connected. This feature is designed to allow vehicle with Variable Voltage alternators to trigger the DC Input. Figure 2.4.2 shows how to wire the Ignition Trigger wire, the wire should be at least 0.5mm² and the fuse must be installed as close as possible to the ignition connection on the vehicle.

The Ignition Trigger feature must be activated in the User Menu as explained in section 3.3 of this manual.

2.4.3 Connecting the Battery Sensor

Wire the Battery Sensor as shown in figure 2.4.1.1 ensuring that the “BNEG” stud connects to the House Battery negative terminal and the “GND” stud connects to the vehicle common ground point.

Connect the CANBus Connection cable, the cable with the RJ12 connector, to the CANBus network via the T-Piece supplied (see figure 2.4.2). The CANBus Connection cable should be connected to the T-Piece using the RJ12 Insert provided.

The Battery Positive Lead connects to the house battery positive terminal, this lead measures voltage and temperature at the battery.

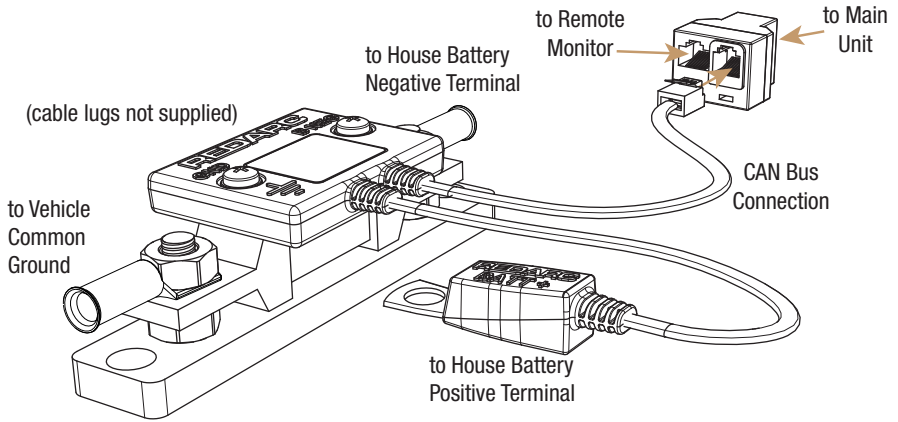

Figure 2.4.1.1 - Battery Sensor connections

2.4.4 Wiring the Main Unit

Refer to Figure 2.4.1 for required connections and to Figure 2.4.2 typical setup.

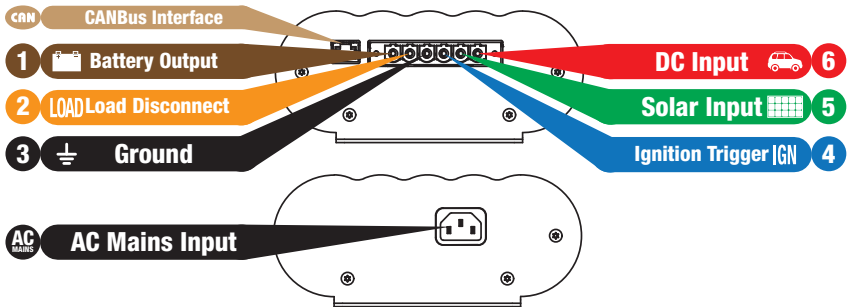

Figure 2.4.1 - Required connections.

NOTE: If a longer Remote Monitor cable is required, a replacement CAT5 patch cable may be used, up to a length of 10m.

Typical Setup (12V or 24V)

- * The size of this fuse relates to the total current draw of all the loads connected to the House Battery and should be rated slightly higher than this.
- ** Essential loads are loads which must be left on at all times, until the battery is flat. Non-essential loads are those switched off when the battery reaches a particular low-charge level, which can be set in the 'Advanced Settings' menu.

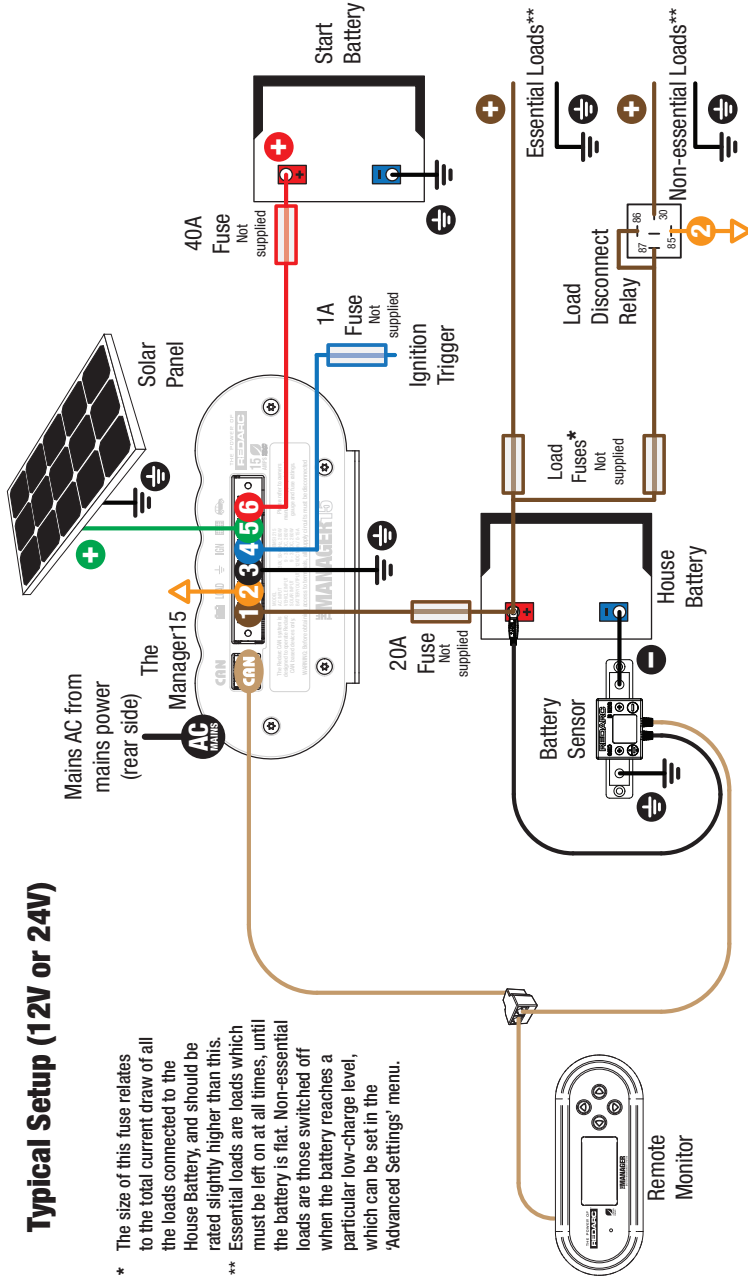

Figure 2.4.2 - Typical setup.

2.5 Batteries

⚠ WARNING

Working in the vicinity of a Lead-Acid battery is dangerous. Batteries generate explosive gases during normal operation. For this reason, batteries must be charged in a well ventilated area. It is of utmost importance that you follow the instructions each time you use the charger.

⚠ CAUTION

When charging a battery, make sure the settings at the Battery Setup menu on the Remote Monitor are correct for the type of battery under charge. Charging a battery with the wrong profile may cause The Manager15 to indicate a fault or give misleading results and could result in damage to the battery. Noticeable oscillations between Boost and Absorption stages indicate the wrong choice of battery type. Check and adjust battery type. If you are unsure of the battery type or settings to use, set The Manager15 to the Gel setting.

Figure 2.5.1 and 2.5.2 show standard wiring for batteries in series and parallel respectively.

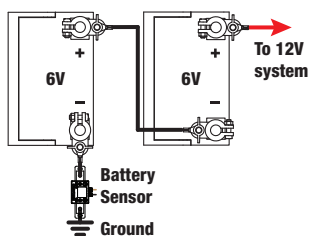

Figure 2.5.1 - Batteries in Series.

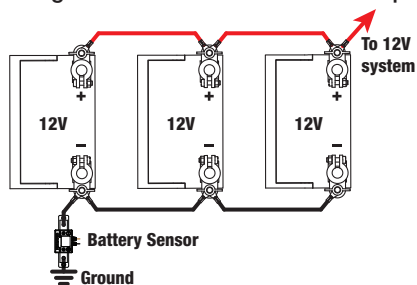

Figure 2.5.2 - Batteries in Parallel.

To ensure that all batteries are equally charged, loads and The Manager15 should be connected with ground and 12V power connected diagonally opposite across all batteries as shown in Figure 2.5.2.

The Ah rating needs to be setup when prompted on first start up (Refer section 3.3), these settings can also be modified in the “Advanced Settings” menu (Refer section 3.5). To calculate Ah rating of batteries in parallel simply add the rating of each battery in the bank together. For example, 3 batteries with an Ah rating of 100Ah each will yield a total of 3 x 100Ah or 300Ah. Batteries connected in series will assume the lowest Ah rating of the batteries in the bank. For example, 2 batteries in the bank, one is 50Ah the other 100Ah. When connected in series the Ah rating is 50Ah.

2.6 MPPT Solar Regulator

The Manager15 is designed for use with 12V solar panels. A minimum input voltage of 17.5V is required to start charging from a solar source. Once charging has started, the operating voltage range of the solar input can go as low as 9V and as high as 32V; outside of this range, charging will stop.

The power output from solar panels varies depending on the amount of sunlight and the electrical load on the solar panel output. The Manager15 utilises a Maximum Power Point Tracking (MPPT) algorithm on the solar input, to ensure that the greatest charge possible is transferred from the solar panels to the battery under charge. As conditions change, the MPPT algorithm adjusts its parameters accordingly, in order to maintain the optimum point at which the solar panels can deliver the most power.

An array of solar panels can be connected to The Manager15 solar input, on the condition that the open circuit output voltage of the array is at least 17.5V and does not exceed 32V. For this reason, 12V panels must be connected in parallel (Refer to Figure 2.6.1). So long as the voltage requirements are met, there is no limit to the number of panels that can be connected in a solar array; however The Manager15 will not draw more than 260W from the solar input.

For installations with a single 12V solar panel, a blocking diode is not necessary. For installations with an array of solar panels, please refer to the panel manufacturer's instructions for requirement and/or fitment of diodes.

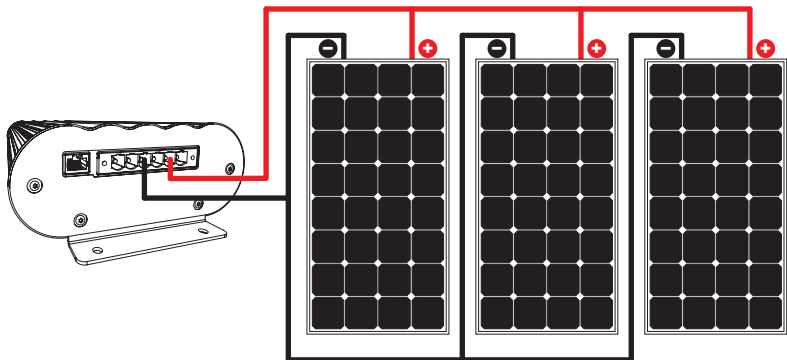

Figure 2.6.1 - Array of 12V Solar Panels

3.1 Remote Monitor

The Remote Monitor is designed to give you control of how the battery is being charged, as well as up-to-date house battery and charge information at any time during the charging process. You can check battery charge status, estimated charge time and State of Charge (SOC) per hour over a day and per day over a month. It also allows you to select charging profiles specific to the battery type and size. The four controls ‘Up’, ‘Down’, ‘Enter’ and ‘Home’ allow you to select options or move in and out of menu items. The Signal Indicator LED will glow Green when suitable AC Mains signal is present and Red in the event of a fault occurring.

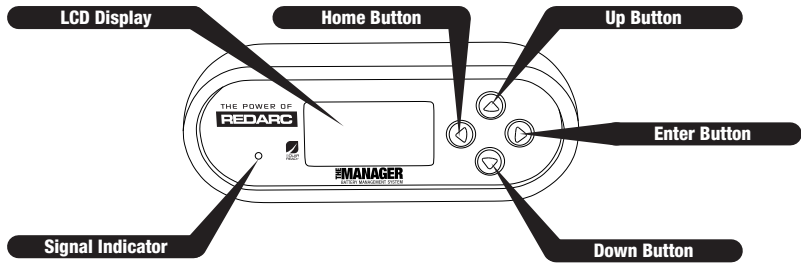

Figure 3.1.1 - The Remote Monitor

3.2 Understanding the Display

The top left corner of the screen always displays the title of the present menu. Use the ‘Up’ and ‘Down’ buttons to move between menus and to change settings such as battery type and contrast level. At any time during operation, the ‘Home’ button will take you back to the Home Screen, unless otherwise specified. The Home Screen can be set to any of the top level User Menu screens described in section 3.4 by pressing and holding the ‘Home’ button for 2 seconds whilst the desired screen is displayed. At any time during operation, the menu at the bottom of the screen will explain the function of the ‘Enter’ and ‘Home’ buttons.

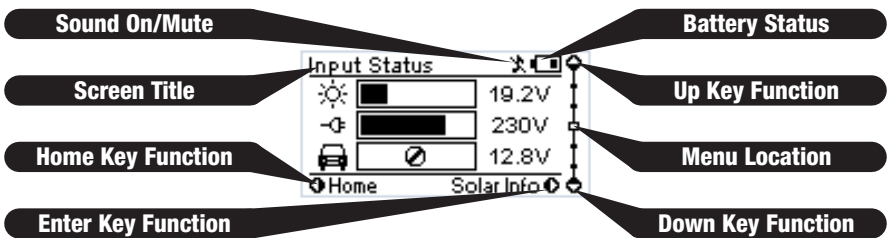

Figure 3.2.1 - The LCD Display

3.3 Initial Setup

When The Manager15 is first switched on the unit will prompt the user to enter a number of settings. It is important to enter these settings accurately as they directly affect the operation and performance of The Manager15.

Set the Language:



The first step required for initial setup is Language selection. Once entered the Language is set in memory and retained should power be lost and reconnected.

- ▶ Edit Battery Type & Size
- ▶ About Screen
- ◀ N/A
- ◀ Remote Settings Screen

Setup your Battery Type:



The second and most important step required for initial setup is Battery Type and Size selection. Please refer to the battery manufacturers specification sheet for Size(AH) and Type specifications. If you are unsure of the type of your battery please select the Gel setting. Should power to the Battery Sensor be removed at any time, the unit will revert to the Gel setting and prompt the user to input their Battery Type again. The Battery Size setting will be retained in memory.

- ▶ Edit Battery Type & Size
- ▶ About Screen
- ◀ N/A
- ◀ Remote Settings Screen

Setup the Date and Time:



The final step required for initial setup is selecting the Time and Date to be displayed on Remote Monitor. Time and Date settings are used not only for the clock screen but also on the Charge per Hour and Charge per Day log screens. The Time and Date settings are not retained in memory so in the event that the charger loses ALL power sources (Input and Output), upon reconnection the unit will prompt the user to enter the Time and Date again.

The Clock screen is also the default Home Screen.

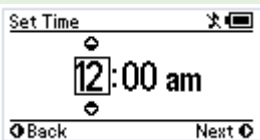

- ▶ Set the Time & Date
- ▶ Charging Status Screen
- ◀ N/A
- ◀ Battery Charge Screen

⚠ CAUTION

When charging a battery, make sure the settings at the Battery Setup menu on the Remote Monitor are correct for the type of battery under charge. Charging a battery with the wrong profile may cause The Manager15 to indicate a fault or give misleading results and could result in damage to the battery. Noticeable oscillations between Boost and Absorption stages indicate the wrong choice of battery type. Check and adjust battery type. If you are unsure of the battery type or settings to use, set The Manager15 to the Gel setting.

3.4 User Menu



The Manager15 features a real time clock (time and date) function which needs to be setup when the power is first connected.

- ▶ Set the Time & Date
- ◀ N/A
- ▲ Charging Status Screen
- ▼ Battery Charge Screen

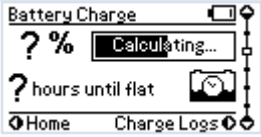

The Manager15 monitors current in and out of the house battery, keeping track of the charge remaining. This screen displays the estimated state of charge of the house battery in percentage along with a bar graph. For the duration of the initial charge cycle for a new battery this screen will show 'Calculating'. This is when The Manager15 is gathering information about the battery under charge. State of Charge is determined by current in or out of the house battery, and uses the first charge cycle (Calculating) and the battery size input by the user at setup to determine what the full State of Charge should be.

Once The Manager15 has calculated the full state of charge for the system this screen will display either the Time to Full Charge or the Battery Time Remaining, depending on whether the house battery is currently being charged or discharged. The Manager15 uses the estimated State of Charge value to calculate, based on the current into and out of the house battery, the time to reach 100% State of Charge. You may use this to decide when to disconnect AC power, for example. Similarly, The Manager15 uses the estimated State of Charge value to calculate - based on the current power usage of the system (e.g. of loads such as fridges, lighting) - the useful time remaining of the battery.

NOTE: Zero State of Charge occurs when The Manager15 determines that the amount of charge removed from the house battery, in Ah, is equal to the amount input by the user at initial setup.

- ▶ View Charge Logs (per Hour)
- ◀ Home Screen (Clock)
- ▲ Home Screen (Clock)
- ▼ Input Status Screen

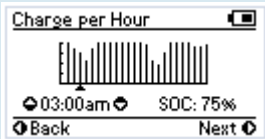
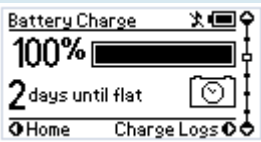

The Charge per Hour screen displays the average State of Charge of the battery under charge at the end of each hour across the course of the last day. The most recent hour is always the right most line on the graph.

- ▶ View Charge Logs (per Day)
- ◀ Battery Charge Screen
- ▲ Previous Hour SoC
- ▼ Next Hour SoC

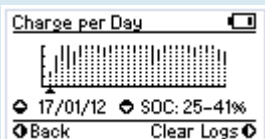

The Charge per Day screen displays the maximum and minimum State of Charge of the battery under charge for each day across the course of the last month. The most recent day is always right most line on the graph.

- ▶ Clear Logs (Hold to Confirm)
- ◀ View Charge Logs (per Day)
- ▲ Previous Day SoC
- ▼ Next Day SoC

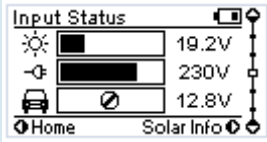

The Input Status screen displays a summary of the inputs to the system. The Solar input is the priority, providing as much usable input power as possible. If another source is present and the Solar input is not providing maximum (15A) input, the other source will attempt to make up the remaining allowable input power. This screen provides input voltage level as well as percentage (bar graph) of input power provided. Only two sources are used at any one time. If a source is not detected a circle with a line diagonally through it will display indicated that the source is not present. If the Solar and AC inputs are both in use and the DC input is detected, the DC voltage will be displayed however the bar graph will display the not available symbol.

- ▶ Solar Information Screen
- ▲ Battery Charge Screen
- ◀ Home Screen (Clock)
- ▼ Output Status Screen

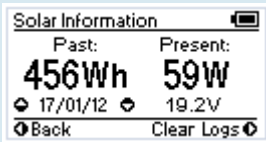

The Solar Information screen displays information on the power and voltage output of the solar panels. From this screen you can access a log of daily power generation measured in Watt Hours. The log will store up to 7 days of data and will overwrite, storing only the last 7 days at any one time.

- ▶ Clear Logs (Hold to Confirm)
- ▲ Previous Day Solar Information
- ◀ Input Status Screen
- ▼ Next Day Solar Information

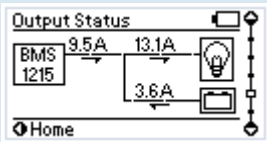

The Output Status screen displays a summary of the current flow of the system. The screen will display current from The Manager15 unit, current in to or out of the battery and current provided to the loads. The direction of the current flow is indicated by the arrows, and a moving white dot.

- ▶ N/A
- ▲ Input Status Screen
- ◀ Home Screen (Clock)
- ▼ Charging Status Screen

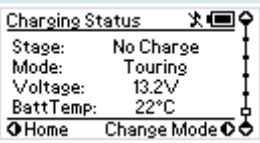

The Charging Status screen displays the charging status of The Manager15, including Charge Stage, Charge Mode and Battery Voltage and Battery Temperature.

- ▶ Change Charging Mode
- ▲ Output Status Screen
- ◀ Home Screen (Clock)
- ▼ Home Screen (Clock)

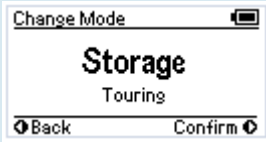

The Change Mode screen allows switching between Touring and Storage modes. Remember to disconnect all loads before setting Storage mode.

- ▶ Confirm Mode Selection
- ▲ Change Mode Selection
- ◀ Charging Status Screen
- ▼ Change Mode Selection

NOTICE

When using the charger in Storage mode, make sure that all loads are disconnected from the house battery under charge. Failure to do so may cause the house battery to be under charged, give false readings on the State of Charge indicator and possibly cause damage to any loads connected.

3.5 Settings Menu



To access the Settings menu both the Up and Down buttons must be held for 2 seconds. This allows you to modify your Battery Setup, Remote Settings and some Advanced Settings, as well as providing a restore Factory Settings option and an About screen.

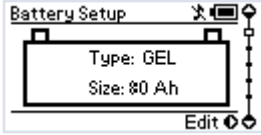

The first screen in the Settings menu is the Battery Setup screen. The Battery Setup displays the selected battery settings for the battery under charge.

- ▶ Edit Battery Type & Size
- ▲ About Screen
- ◀ N/A
- ▼ Remote Settings Screen

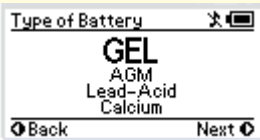

The Type of Battery screen allows the user to indicate the type of battery being charged by The Manager15. This setting will affect the charge profile that The Manager15 uses to charge the battery so it is important to select the correct battery type. Once you are happy with your selection move on to the Size of Battery screen.

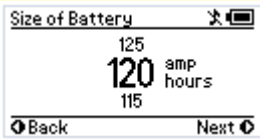

The Size of Battery screen allows the user to indicate the battery bank size. When you have chosen this value, the menu will ask for confirmation of the settings while displaying them on the screen. Refer section 2.5 for battery size calculation.

- ▶ Next menu/Confirm
- ▲ Cycle through options
- ◀ Back/Cancel
- ▼ Cycle through options

⚠ CAUTION

When charging a battery, make sure the settings at the Battery Setup menu on the Remote Monitor are correct for the type of battery under charge. Charging a battery with the wrong profile may cause The Manager15 to indicate a fault or give misleading results and could result in damage to the battery. Noticeable oscillations between Boost and Absorption stages indicate the wrong choice of battery type. Check and adjust battery type. If you are unsure of the battery type or settings to use, set The Manager15 to the Gel setting.

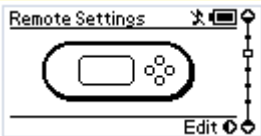

The Remote Settings Menu allows modification of settings relating to the Remote Display and its operation.

- ▶ Remote Settings Menu
- ▲ Battery Setup Screen
- ◀ N/A
- ▼ Advanced Settings Screen

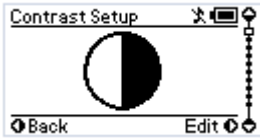

The Remote Settings menu allows modification of the settings listed below.

- Edit Selected Setting
- Cycle through Settings
- Remote Settings Screen
- Cycle through Settings

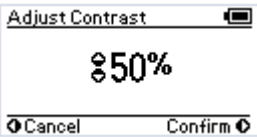
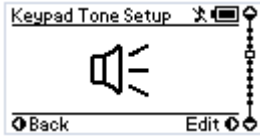
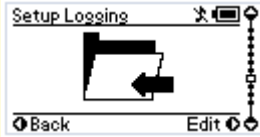
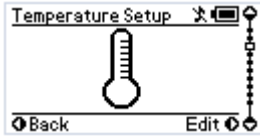
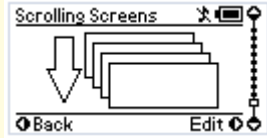
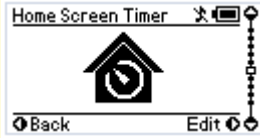
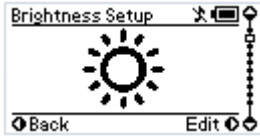
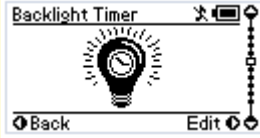
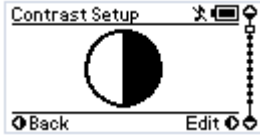

Each setting can be adjusted using the 'Up' and 'Down' controls.

- Confirm Setting Adjustment
- Adjust Setting (Up)
- Cancel Setting Adjustment
- Adjust Setting (Down)



The Advanced Settings menu allow modification of settings relating to advanced operations of The Manager15 unit.

- MaxCharge Current Setting
- Remote Settings Screen
- N/A
- Restore Factory Settings Screen

NOTICE

Modification of the 'Advanced Settings' menu items affect the way The Manager15 unit responds to charging situations. Modification of these settings may result in the unit not functioning at 100% of its capacity. These settings should only be modified if absolutely necessary and when the effects of the changes are 100% understood.

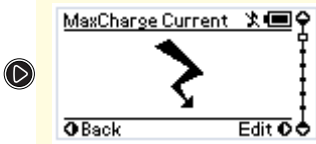

The MaxCharge Current setting refers to the amount of current permitted by The Manager15 to charge the battery, up to a maximum of 15 Amps.

- ⏪ Set Charging Current Screen
- ⏩ R-Bus Diagnostics Screen
- ⏪ Advanced Settings Screen
- ⏩ Low SOC Alarm Screen

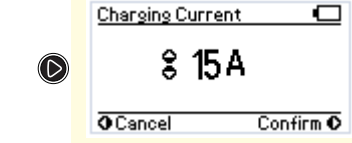

If the Charging Current setting is set lower than 15 Amps the excess current will be used to supply the loads running from the battery under charge.

- ⏪ Confirm Setting
- ⏩ Increase Charging Current
- ⏪ Cancel Setting
- ⏩ Decrease Charging Current

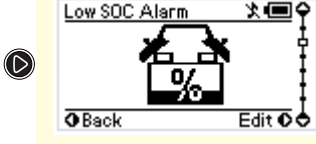

The Low SOC Alarm setting will sound an alarm when the battery State-of-Charge reaches a particular setting.

- ⏪ Set Alarm SOC Screen
- ⏩ MaxCharge Current Screen
- ⏪ Advanced Settings Screen
- ⏩ Low Voltage Alarm Screen

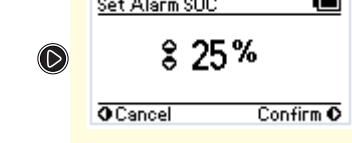

The Set Alarm SOC setting sets the percentage of State-of-Charge at which the alarm will sound. The Alarm SOC can be set to from 0 - 100%.

- ⏪ Confirm Setting
- ⏩ Increase Alarm SOC
- ⏪ Cancel Setting
- ⏩ Decrease Alarm SOC



The Low Voltage Alarm setting will sound an alarm when the battery Voltage reaches a particular setting.

- ⏪ Set Alarm Voltage Screen
- ⏩ Low SOC Alarm Screen
- ⏪ Advanced Settings Screen
- ⏩ Load Disconnect Screen

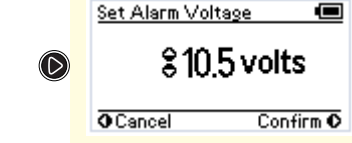

The Set Alarm Voltage setting sets the Voltage at which the alarm will sound. The Alarm Voltage can be set to OFF.

- ⏪ Confirm Setting
- ⏩ Increase Alarm Voltage
- ⏪ Cancel Setting
- ⏩ Decrease Alarm Voltage

NOTICE

It is recommended to set the SoC or Voltage Alarm level above the Load Disconnect Turn OFF level and below the Turn ON level. This will ensure that, in the event the loads have been disconnected, when reconnection occurs the Alarm does not sound.

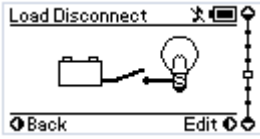

The Load Disconnect setting will output a GROUND relay trigger signal based on a user set SOC or voltage level.

- ▶ Disconnect Trigger Screen
- ▶ Low Voltage Alarm Screen
- ▶ Advanced Settings Screen
- ▶ Set DC Input Trigger Screen

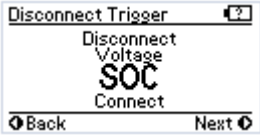

The Disconnect Trigger setting can be set to Disconnect (Loads OFF), Connect (Loads ON) or to operate from either SOC or Voltage level triggers.

- ▶ Next Menu Item
- ▶ Change Setting
- ▶ Back
- ▶ Change Setting

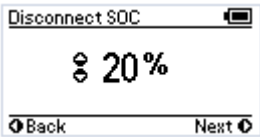

If either Voltage or SOC are selected at the Disconnect Trigger setting screen the Disconnect trigger level will need to be selected.

Once the Disconnect trigger level is selected the Reconnect trigger level must be selected. Note that there is a built in minimum hysteresis constraint on this setting and a non-adjustable time delay exists to stop repetitive switching.

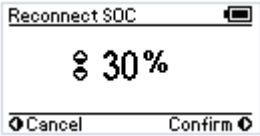

- ▶ Next Menu Item/Confirm
- ▶ Increase Setting
- ▶ Back/Cancel
- ▶ Decrease Setting

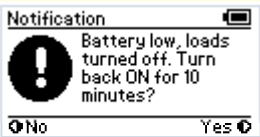

Should the Load Disconnect feature be triggered the Remote Monitor will prompt the user to allow the Loads to be reconnected for 10 minutes. This allows the user to temporarily use power (for loads such as lighting) to rectify any issues and/or engage another charging source. After this time has lapsed the load will disconnect and the prompt will reappear, unless the battery voltage is above the Disconnect level.

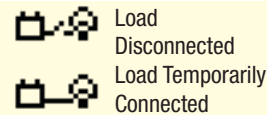

- ▶ Turn Loads ON for 10 mins
- ▶ N/A
- ▶ No
- ▶ N/A

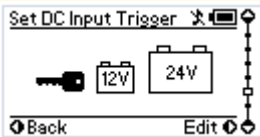

The DC Input Trigger allows you to select whether you would like your DC input to be triggered via Ignition, automatically via The Manager15, or at a specific voltage.

- ▶ Set DC Input Trigger Screen
- ▶ Load Disconnect Screen
- ▶ Advanced Settings Screen
- ▶ R-Bus Diagnostics Screen

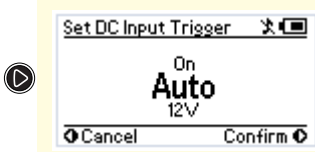

Ignition selects Ignition Trigger, Auto is controlled by The Manager15, and 12V or 24V lock the unit to a 12V or 24V system. ON means the unit can trigger DC charging whenever there is a voltage between 9 - 32V on the DC Input wire. The default value is 'Auto'.

- ⏪ Confirm Setting
- ⏩ Change Setting
- ⏴ Cancel Setting
- ⏵ Change Setting

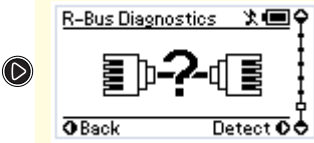

This screen is used by REDARC to identify problems with a The Manager15 setup and does not need to be accessed unless requested by REDARC Technicians.

- ⏪ Start Process/ More Info
- ⏩ Set DC Input Trigger Screen
- ⏴ Advanced Settings Screen
- ⏵ MaxCharge Current Screen

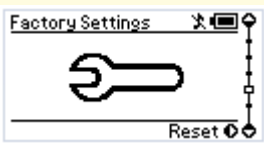

This screen gives the option of restoring the Factory Settings for The Manager15. A list of the factory settings can be found on Page 34.

- ⏪ Restore Settings/ Confirm
- ⏩ Advanced Settings Screen
- ⏴ N/A
- ⏵ About Screen

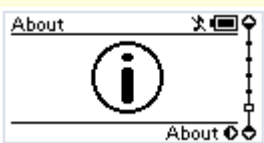

The About Screen allows you to access information about the build of The Manager15 and the company. You may be asked to access this menu should you ever call up for technical support with The Manager15.

- ⏪ About your Manager15
- ⏩ Factory Settings Screen
- ⏴ N/A
- ⏵ MaxCharge Current Screen

3.6 Fault Screens



If The Manager15 detects a problem with the charging system that does not prevent it from charging the battery, it will alert you via a Warning screen and an alarm buzzer, and continue charging. The screen will give a brief description of the problem and allow you to select either 'Clear' or 'Ignore'. Both options will clear the warning screen. After selecting 'Clear', however, The Manager15 will immediately check to see if the fault condition still exists. If it does, it will display the warning screen again. Selecting 'Ignore' will prevent The Manager15 from detecting the same fault for up to one minute.

NOTE: If "Ignore" is selected but the fault is not removed, when the warning re-appears after one minute, it will not be accompanied by the alarm buzzer. The troubleshooting section (3.7) of this manual contains a description of faults detected.

- ⏪ Clear Warning
- ⏩ N/A
- ⏴ Ignore Warning
- ⏵ N/A

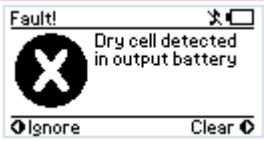

If The Manager15 detects a problem with the charging system that prevents it from continuing to charge the battery, it will alert you via a 'Fault' screen and an alarm buzzer, and will instantly terminate the charging cycle until the fault condition is cleared. The screen will give a brief description of the problem and will allow you to select either 'Clear' or 'Ignore'. Both options will clear the fault screen. After selecting 'Clear', however, The Manager15 will immediately check to see if the fault condition still exists. If it doesn't, the unit will restart charging. Selecting 'Ignore' will simply hide the fault screen for up to one minute. It will not allow The Manager15 to recommence charging unless The Manager15 itself detects the removal of the fault condition.

NOTE: If "Ignore" is selected but the fault is not removed, when the warning re-appears after one minute, it will not be accompanied by the alarm buzzer. The troubleshooting section (3.7) of this manual contains a description of faults detected.

-  Clear Fault  N/A
-  Ignore Fault  N/A

3.7 Troubleshooting

The Manager15 is designed to detect and advise the operator of a variety of fault conditions and will terminate the charging cycle immediately should a critical fault be detected. This ensures that it will not attempt to charge a faulty battery, which protects The Manager15, house battery and most importantly the user.

The Remote Display is used to inform the user of the nature of the problem whenever possible. These indicators should be used to diagnose, and if possible correct any faults that may occur. When attempting to diagnose a fault, cabling should be adequately rated and all components, including all input sources and house battery should be connected as close as possible to The Manager15.

The listing on the following page (33) outlines the probable cause and recommended action to take when faults occur with The Manager15 system.

If after attempting to rectify the situation, a fault still occurs, please contact REDARC for further diagnosis.

Contact Details:
 REDARC Electronics
 +61 8 8322 4848
power@redarc.com.au
www.redarc.com.au

Faults

CHARGER FAULT MESSAGE	CAUSE	ACTION
Charger over current fault	An internal error has caused excessive current draw	Return to supplier
Charger over voltage fault	The output voltage is too high (above 18V)	Check battery is correct type (12V, 6 cell)
Unit over temperature fault. Allow to cool	The unit has over heated	Allow to cool, charging will recommence automatically
Output battery under temperature fault	Output battery is below 0°C	Charger will halt charging until battery is above 5°C
Output battery over temperature fault	Output battery is above 60°C	Charger will halt charging until battery is below 55°C
Dry cell detected in output battery	Charger has detected a dry cell in output battery	Replace battery
Shorted cell detected in output battery	Charger has detected a shorted cell in output battery	Replace battery

Warnings

CHARGER WARNING MESSAGE	CAUSE	ACTION
AC supply over voltage	The internal AC converter output voltage is too high	Contact supplier
AC supply over temperature	The internal AC converter temperature is too high	Contact supplier
DC supply over voltage	The DC input voltage is too high (over 32V)	Check DC input, refer to specified input range
Solar supply over voltage	The solar input voltage is too high (above 32V)	Check solar input, refer to specified input range
No battery sensor connected	The supplied battery sensor is not connected or is faulty	Connect battery sensor, if faulty return to supplier
Low battery State of Charge	House battery is almost flat	Reduce/remove loads on house battery
Bad cable detected	Too much voltage drop between charger and battery sensor	Check cable for correct sizing requirements
Load Disconnect output shorted	Load disconnect output faulty	Contact supplier
Battery voltage low! Disconnect all loads	Loads exceeding charge available from input sources	Connect additional input source or disconnect loads

Other issues

FAULT	ACTION
Low output current can occur when the unit is hot and temperature derating is implemented to protect the Charger	Check that the unit is in a well ventilated space
The current display shows a negative current when there are no loads on the house battery and the house battery is charging	The current shunt connection is reversed
Noticable oscillations between Boost and Absorption stages	Check and select the correct battery type

3.8 Factory Settings

The Manager15 is shipped with a number of settings already programmed into the unit. These settings are set to ensure that the charger will safely charge any battery and may not reflect the actual requirements for your battery type. It is important to review these settings and adjust as required.

Setting	Factory Value
Battery Type	GEL
Capacity	40AH
Charge Mode	TOURING
Temperature Scale	Celsius
Key Tone Status	ON
Contrast	50%
Brightness	90%
Backlight Timer	30 secs
Home Screen Timer	30 secs
Time/Date Format	12 Hour/DD/MM/YYYY
Language	English
Max Charge Current	15 Amps
Low SOC Alarm	10%
Low Voltage Alarm	10.5 Volts
Load Disconnect	Off
DC Input Trigger	Auto

NOTICE

Modification of the 'Advanced Settings' menu items affect the way The Manager15 unit responds to charging situations. Modification of these settings may result in the unit not functioning at 100% of its capacity. These settings should only be modified if absolutely necessary and when the effects of the changes are 100% understood.

3.9 Frequently Asked Questions

- Q I have damaged my Power Cable and need to replace it, do I have to buy a special kind of cable.
- A To ensure the correct operation of The Manager15, REDARC advise that if the supply cord is damaged it must be replaced by a special cord available from the manufacturer.
- Q I am running a load from my house battery, but it does not seem to register on The Manager15 Remote, why can I not see this current draw?
- A This is generally caused by incorrect wiring of the Battery Sensor. Ensure no equipment earths go direct to the house battery negative or to the house battery end of the shunt. They must all go to common or chassis ground or to the ground end of the shunt
- Q My Input Status screen shows a voltage on the Solar input but the bar graph shows that no charge is coming from the Solar input, what does this mean?
- A A partially shaded panel (or low-light conditions such as dawn or dusk) will increase the target solar panel voltage level to match the maximum power point. In this situation solar will be selected as a source however little or no current will be flowing into the battery.

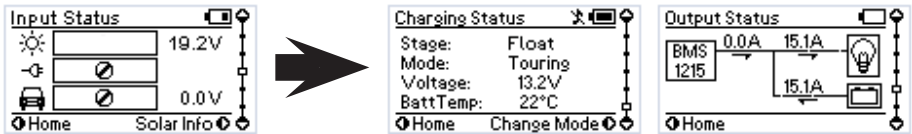

- Q I have just finished wiring The Manager15 and when i turn the unit on the Remote Monitor says 'No Battery Sensor Detected', is my unit faulty?
- A The Battery Sensor has a timeout function in-built into the unit. If the Battery Sensor is wired to Power and Ground for a considerable amount of time before the Main Unit is connected this message may appear. Try disconnecting the Red Battery Positive terminal of the Battery Sensor and reconnecting it. If the message appears again please contact REDARC Electronics.

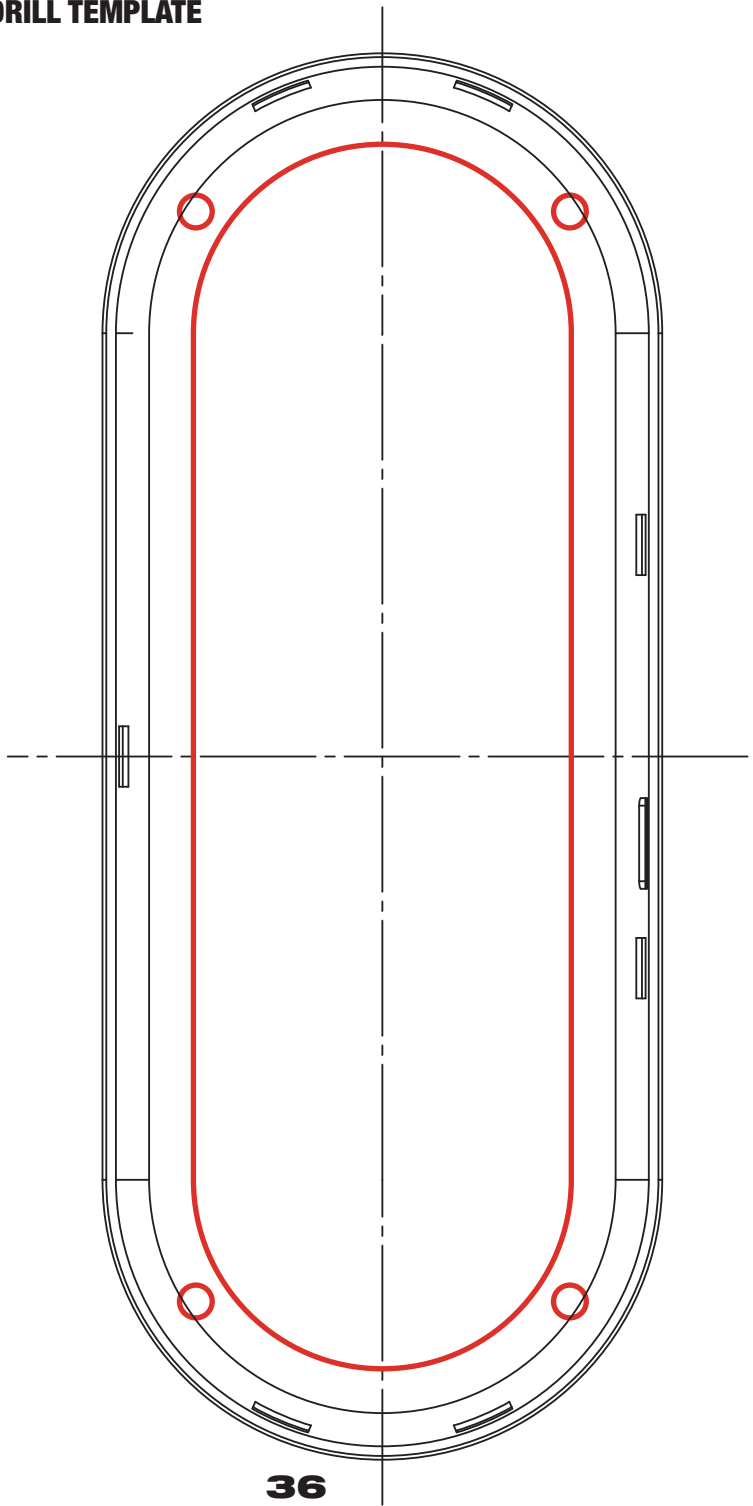

THIS PAGE INTENTIONALLY LEFT BLANK

5 TWO YEAR PRODUCT WARRANTY

Over the last three decades our company has established a reputation as the power conversion specialist.

A 100% Australian-owned company, we have met the needs of customers in transport and other industries through exciting, innovative thinking.

We believe in total customer satisfaction and practice this by offering our customers:

- Technical advice free of jargon and free of charge
- Prompt turnaround of orders throughout Australia and globally
- Friendly, personalised, professional service and product support

In the unlikely event that a technical issue arises with a Redarc product, customers are encouraged to initially contact the Redarc Technical Support Team on (08) 8322 4848 or power@redarc.com.au for prompt and efficient diagnosis and product support.

Our goods come with guarantees that cannot be excluded under the Australian Consumer Law. You are entitled to a replacement or refund for a major failure and compensation for any other reasonably foreseeable loss or damage. You are also entitled to have the goods repaired or replaced if the goods fail to be of acceptable quality and the failure does not amount to a major failure.

The benefits of this Warranty are in addition to other rights and remedies available at law in respect of the Products and shall not derogate from any applicable mandatory statutory provisions or rights under the Australian Consumer Law.

Redarc Electronics Pty Ltd aff the Redarc Trust trading as Redarc Electronics ("Redarc") offers a warranty in respect of its Products where the Products are purchased from an authorised distributor or reseller of Redarc by a person ("Purchaser"), on the terms and conditions, and for the duration, outlined below in this document ("Warranty").

1. In this Warranty, the term **Products** means:

- 1.1 all products manufactured or supplied by Redarc (excluding its solar products which are covered by Redarc's Solar Product Warranty); and
- 1.2 any component of or accessory for any product in clause 1.1 manufactured or supplied by Redarc.

Offer and duration of product warranties

2. Redarc warrants that its Products will be free, under normal application, installation, use and service conditions, from defects in materials and workmanship affecting normal use, for **2 years** from the date of purchase (**Warranty Period**).

3. Where a Product malfunctions or becomes inoperative during the Warranty Period, due to a defect in materials or workmanship, as determined by Redarc, then subject to further rights conferred by the Australian Consumer Law on the Purchaser, Redarc will, in exercise of its sole discretion, either:

- 3.1 repair the defective Product;
- 3.2 replace the defective Product; or
- 3.3 provide a refund to the Purchaser for the purchase price paid for the defective Product,

without charge to the Purchaser.

4. The warranty given by Redarc in clause 3 covers the reasonable costs of delivery and installation of any repaired or replaced Products or components of Products to the Purchaser's usual residential address notified to Redarc, together with the reasonable costs of removal and return of any Products determined by Redarc to be defective.

5. If the Purchaser incurs expenses of the nature referred to in clause 4 in the context of making a claim pursuant to this Warranty that is accepted by Redarc, the Purchaser will be entitled to claim for reimbursement of those expenses which Redarc determines, in exercise of its sole discretion, to be reasonably incurred, provided that the claim is notified to Redarc in writing at the postal address or email address specified in clause 21 and includes:

- 5.1 details of the relevant expenses incurred by the Purchaser; and
- 5.2 proof of the relevant expenses having been incurred by the Purchaser.

Exclusions and limitations

6. This Warranty will not apply to, or include any defect, damage, fault, failure or malfunction of a Product, which Redarc determines, in exercise of its sole discretion, to be due to:

- 6.1 normal wear and tear or exposure to weather conditions over time;
- 6.2 accident, misuse, abuse, negligence, vandalism, alteration or modification;
- 6.3 non-observance of any of the instructions supplied by Redarc, including instructions concerning installation, configuring, connecting, commissioning, use or application of the Product, including without limitation choice of location;
- 6.4 failure to ensure proper maintenance of the Product strictly in accordance with Redarc's instructions or failure to ensure proper maintenance of any associated equipment or machinery;
- 6.5 repairs to the Product that are not strictly in accordance with Redarc's instructions;
- 6.6 installation, repairs or maintenance of the Product by, or under the supervision of, a person who is not a qualified auto electrician or technician, or if non-genuine or non-approved parts have been fitted;
- 6.7 faulty power supply, power failure, electrical spikes or surges, lightning, flood, storm, hail, extreme heat, fire or other occurrence outside the control of Redarc;
- 6.8 use other than for any reasonable purpose for which the Product was manufactured;
- 6.9 any indirect or incidental damage of whatever nature outside the control of Redarc.

7. Warranty claims in respect of a Product must be made in writing to Redarc at the postal address or email address specified in clause 21 within the Warranty Period. Such claims must include the following:

- 7.1 details of the alleged defect or fault and the circumstances surrounding the defect or fault;
- 7.2 evidence of the claim, including photographs of the Product (where the subject of the claim is capable of being photographed);
- 7.3 the serial number of the Product, specified on the label affixed to the Product; and
- 7.4 proof of purchase documentation for the Product from an authorised distributor or reseller of Redarc, which clearly shows the date and place of purchase.

The return of any Products without the prior written instructions of Redarc will not be accepted by Redarc.

8. Without limiting any other clause in this Warranty, Redarc has the right to reject any Warranty claim made by a Purchaser pursuant to this Warranty where:

- 8.1 the Purchaser does not notify Redarc in writing of a Warranty claim within the Warranty Period;
 - 8.2 the Purchaser does not notify Redarc in writing of a Warranty claim within 1 month of becoming aware of the relevant circumstances giving rise to the claim, so that any further problems with the Product are minimised;
 - 8.3 the serial number of the Product has been altered, removed or made illegible without the written authority of Redarc;
 - 8.4 the Purchaser is unable to provide proof of purchase documentation in accordance with clause 7.4 or evidence that the Product was properly installed and removed (if relevant), and that proper maintenance has been performed on the Product, by, or under the supervision of, a qualified auto electrician or technician, in accordance with the instructions of Redarc.
9. If the Product is found to be working satisfactorily on return to Redarc or upon investigation by Redarc, the Purchaser must pay Redarc's reasonable costs of testing and investigating the Product in addition to shipping and transportation charges. Where Redarc is in possession of the Product, the Product will be returned to the Purchaser on receipt of the amount charged.
10. Any replaced Products or components of Products shall become the property of Redarc.
11. Redarc may, in exercise of its sole discretion, deliver another type of Product or component of a Product (different in size, colour, shape, weight, brand and/or other specifications) in fulfilling its obligations under this Warranty, in the event that Redarc has discontinued manufacturing or supplying the relevant Product or component at the time of the Warranty claim, or where such Product or component is superior to that originally purchased by the Purchaser.

Other conditions of Warranty

12. If the Purchaser acquired a Product for the purpose of resupply, then this Warranty shall not apply to that Product.
13. In particular, the sale of a Product via an online auction, online store or other internet website by a party that is not an authorised distributor or reseller of the Product will be deemed to be a resupply within the meaning of the Australian Consumer Law and will render this Warranty void, as Redarc has no control over the storage, handling, quality or safety of Products sold by such persons.
14. A Purchaser shall only be entitled to the benefit of this Warranty after all amounts owing in respect of the Product have been paid.
15. While Redarc warrants that the Products will be free from defects in materials and workmanship in the circumstances set out in this Warranty, to the maximum extent permitted by law Redarc does not warrant that the operation of the Products will be uninterrupted or error-free.
16. To the maximum extent permitted by law, Redarc's determination of the existence of any defect and the cause of any defect will be conclusive.
17. Spare parts or materials for the Products are guaranteed to be available for a period of at least 2 years after purchase of the Products.
18. The agents, officers and employees of any distributor or reseller of the Products and of Redarc are not authorised to vary or extend the terms of this Warranty.
19. Redarc shall not be responsible or liable to the Customer or any third party in connection with any non-performance or delay in performance of any terms and conditions of this Warranty, due to acts of God, war, riots, strikes, warlike conditions, plague or other epidemic, fire, flood, blizzard, hurricane, changes of public policies, terrorism and other events which are beyond the control of Redarc. In such circumstances, Redarc may suspend performance of this Warranty without liability for the period of the delay reasonably attributable to such causes.
20. If a clause or part of a clause in this Warranty can be read in a way that makes it illegal, unenforceable or invalid, but can also be read in a way that makes it legal, enforceable and valid, it must be read in the latter way. If any clause or part of a clause in this Warranty is illegal, unenforceable or invalid, that clause or part is to be treated as removed from this Warranty, but the rest of this Warranty is not affected.

Redarc's contact details

21. Redarc's contact details for the sending of Warranty claims under this Warranty are: Redarc Electronics Pty Ltd
23 Brodie Road (North), Lonsdale SA 5160
Email: power@redarc.com.au
Telephone: +61 8 8322 4848

THE POWER OF
REDARC®

Free technical assistance!

please contact

REDARC Electronics

23 Brodie Road North, Lonsdale SA

+61 8 8322 4848

power@redarc.com.au

www.redarc.com.au

Copyright © 2018 REDARC Electronics Pty Ltd. All rights reserved.