

POWRTOUCH CARAVAN MOVERS REMOTE CONTROL CARAVAN MOVER FAMILY EVOLUTION TWIN / ALL WHEEL DRIVE AUTO

**INSTRUCTIONS for the Installation, Operation, Use,
Safety & Maintenance of the Powrtouch Evolution Auto**



IF YOU HAVE PURCHASED DIRECTLY FROM POWRTOUCH your proof of purchase will state your unique Powrtouch Evolution Serial Numbers. Please write them on the front of this document for your convenience.

IF YOU HAVE PURCHASED FROM ANOTHER SUPPLIER then they should register your information with Powrtouch (**ALWAYS ASK YOUR SUPPLIER TO MAKE SURE THAT THIS HAS BEEN DONE**).

PLEASE NOTE THAT YOUR POWRTOUCH EVOLUTION GUARANTEE IS NOT AUTOMATICALLY TRANSFERABLE TO A SECOND OWNER
see Section 5 – Paragraph 5.1 of this document.

BEFORE CONTACTING POWRTOUCH WITH A FAULT OR GUARANTEE ENQUIRY PLEASE PAY SPECIAL ATTENTION TO SECTION 4 OF THIS DOCUMENT.

CUSTOMER NAME:.....

POWRTOUCH EVOLUTION SERIAL No: EVA/...../.....

ELECTRONICS SERIAL No: CDFM/.....

Truma Limited

Powrtouch – A Truma Brand

2000 Park Lane, Dove Valley Park, Foston, South Derbyshire, DE65 5BG United Kingdom

TELEPHONE: +44 (0)1283 587900 **FAX:** +44 (0)1283 587910

WEBSITE: www.powrtouch.com **EMAIL:** info@powrtouch.com

TWITTER: www.twitter.com/powrtouchuk



ISSUE 10

CONTENTS

SECTION 1 – USING YOUR POWRTOUCH EVOLUTION SAFELY

- 1.1 Safety Checks Required Prior to Using Your Powrtouch Evolution
- 1.2 Emergency Switch Off/Stop
- 1.3 Safety and Technical Awareness

SECTION 2 – OPERATION OF YOUR POWRTOUCH EVOLUTION

- 2.1 Powrtouch Evolution Operation
- 2.2 Switching On the Powrtouch
- 2.3 Switching On the Handset
- 2.4 Handset Battery Replacement
- 2.5 Engagement of the Rollers Onto the Tyres
- 2.6 Moving the Caravan (Handset Operation)
- 2.7 Decreasing and Increasing Speed
- 2.8 Precision Control of the Caravan Using the Electronic Soft Start Function
- 2.9 Retraction of the Rollers From the Tyres
- 2.10 Switching Off the Unit
- 2.11 Mapping Instructions
- 2.12 Fitting and Removal of the Covers

SECTION 3 – DIY FITTING INSTRUCTIONS (FOR UK SPEC CARAVANS ONLY)

- 3.1 Receiving Your Powrtouch Evolution
- 3.2 Tooling & Equipment Required
- 3.3 Installing Your Powrtouch Evolution
- 3.4 Checking Chassis Depth
- 3.5 Special Mounting Plates
- 3.6 Mechanical Assembly
- 3.7 Electrical Assembly
- 3.8 Connecting to the Caravan Battery

SECTION 4 – LOOKING AFTER YOUR POWRTOUCH EVOLUTION

- 4.1 Cleaning Your Powrtouch Evolution
- 4.2 Cleaning the Drive Rollers

SECTION 5 – GUARANTEE & FAULT FINDING

- 5.1 Powrtouch Evolution Guarantee
- 5.2 Reporting a Fault with Your Powrtouch Evolution
- 5.3 Electronics Control Box (ECB) - LED Status
- 5.4 Checking the Charge State of Your 12 Volt Battery
- 5.5 Fault Finding on Your Powrtouch Evolution

SECTION 1 – USING YOUR POWRTOUCH EVOLUTION SAFELY

1.1 SAFETY CHECKS REQUIRED PRIOR TO USING YOUR POWRTOUCH EVOLUTION

PLEASE READ CAREFULLY:

Before moving the caravan with the Powrtouch Evolution, for safety reasons it should always be tested first. To do this turn on the Powrtouch Evolution at the Isolation Switch – **DO NOT PUT THE ROLLERS ON TO THE TYRES**. With the rollers off the tyres check the handset functions drive the rollers correctly. Once this test has been satisfactorily completed only then should you engage the rollers to the tyres and commence to move the caravan.

IF IN DOUBT CONTACT POWRTOUCH

1.2 EMERGENCY SWITCH OFF/STOP



NB. In the unlikely event of the Powrtouch Evolution malfunctioning, the system can be switched off by pressing either of the 'On/Emergency Stop' buttons (D or F) on the handset. Then turn off the Powrtouch Evolution at the Isolation switch and remove the key. **DO NOT** switch the Powrtouch Evolution back on before consulting a qualified Powrtouch Engineer.

1.3 SAFETY & TECHNICAL AWARENESS

Please read the following instructions and technical information carefully and become familiar with the various components and controls prior to assembly and/or operation. Safety must always be the first consideration in fitting and operation. Failure to comply with these instructions could invalidate your Powrtouch guarantee. If you are in any doubt about the assembly or operation of the product consult a qualified Powrtouch Engineer, for which contact details are shown on the front cover.

- The Powrtouch Evolution Caravan Mover (except handset) is a 12volt DC powered device and it should not under any circumstances be powered by any other power source than a 12volt DC leisure battery. **NB. Using the Powrtouch Evolution with the**

caravan connected to the 240volt mains could cause damage to the caravan internal charging system.

- The 12volt leisure battery **MUST** be fully charged and in good condition to enable the Powrtouch Evolution to operate to its full performance specification – to check your battery see Section 5 Paragraph 5.4 of this instruction manual.
- The handset is powered by a 9volt DC battery (PP3 or equivalent).
- The wiring and cabling supplied by Powrtouch for the installation of the Powrtouch Evolution are to the correct voltage and current rating, under **NO** circumstance should any other wiring or cabling be used unless supplied by Powrtouch or written approval is given for their use. If cutting motor cables (not recommended) these should be kept of equal length, no cable joining system should be used to lengthen them.
- When the Powrtouch Evolution is switched on and/or in use there will be 12volts at the two battery terminals on the Electronics Control Box (ECB). Under no circumstance should any metal object be allowed to touch these terminals.
- The Powrtouch Evolution is not a caravan jacking point and should never be used as such.
- The Powrtouch Evolution is not a brake or braking system and should never be used as such. When stopped always apply the caravan handbrake and remove the rollers from the tyres.
- Be aware that the Powrtouch Evolution adds weight to the caravan and the corresponding weight of your mover must be considered when calculating your payload. If in doubt the MTPLM of the caravan should be checked on a calibrated weighbridge.
- Never allow children or persons unfamiliar with the use of the Powrtouch Evolution to operate the unit.
- When operating the Powrtouch Evolution, please ensure that no object (e.g. Body parts, clothing, hair or any other objects carried on the body) can become trapped by any moving parts of the mover (e.g. rollers).

SECTION 2 – OPERATION OF YOUR POWRTOUCH EVOLUTION

2.1 POWRTOUCH EVOLUTION OPERATION:

Carry out the Powrtouch Evolution pre-movement safety checks as Section 1 Paragraph 1.1; also ensure that the caravan is safe to move and that there are no obstructions to prevent the engagement of the drive rollers to the caravan tyres.

2.2 SWITCHING ON THE POWRTOUCH EVOLUTION

The Powrtouch Evolution control system is switched on by inserting the key into the isolation switch and then turning the key clockwise, the isolation switch is usually situated in the sealed area of the caravan battery box. The green light should illuminate on the ECB situated in the caravan. (See Section 5 Paragraph 5.3)

NOTE: When the Powrtouch Evolution is not in use it **MUST** always be turned off at the Isolation Switch and the key removed. If left switched on it will stay live for 20 minutes (approx.) before the ECB will go in to a hibernation mode. The ECB can only be reinitialised by the following: -

- 1) Turning off the isolation switch
- 2) Remove the key from the switch
- 3) Wait for a minimum of 20 seconds
- 4) Then reinsert the isolation switch key and turn on
- 5) Turn on the handset and use the Powrtouch Evolution

WHEN NOT IN USE ALWAYS SWITCH IT OFF AND REMOVE THE KEY

2.3 SWITCHING ON THE HANDSET

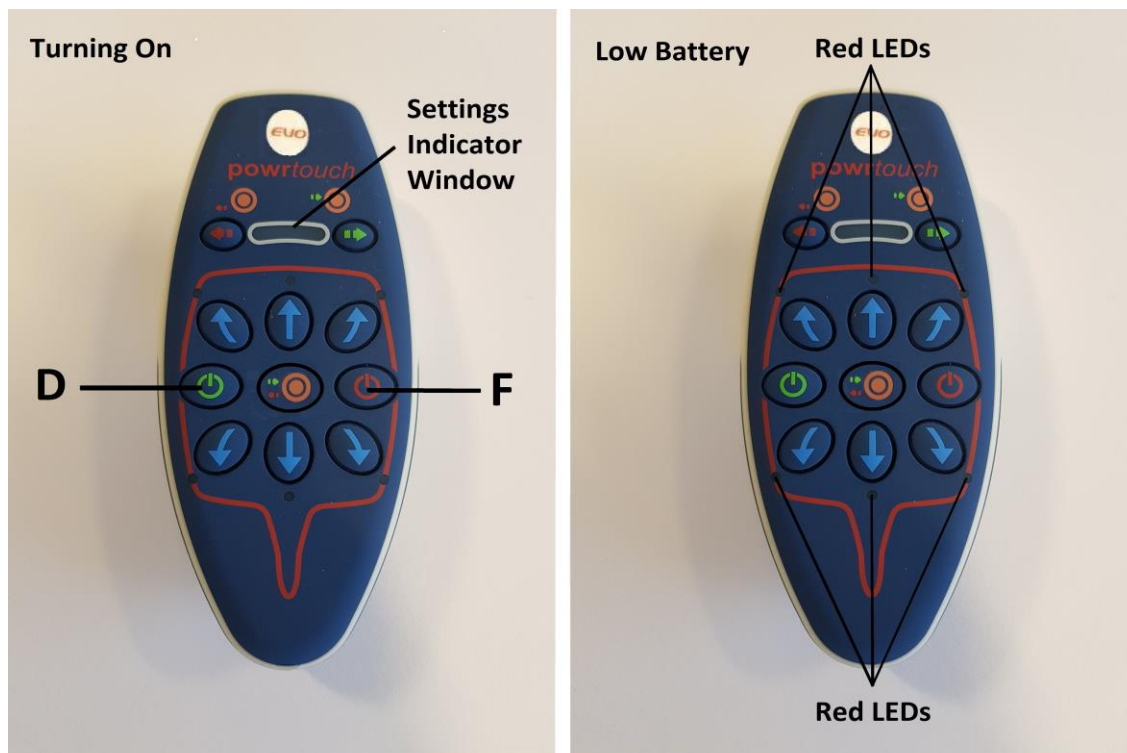

To switch on the handset press both the 'On' buttons (D and F) at the same time. Release them both when the LED array lights up in the settings indicator window. Once it is ready to operate then one green LED on the extreme right of the settings indicator window will remain on. If the top row & bottom row of Red LEDs flash alternating, then this is an indication that the handset battery voltage is low and the battery should be changed as soon as possible.

2.4 HANDSET BATTERY REPLACEMENT

To replace the handset battery the first step is to remove the small cross head screw on the back of the handset. When the small cross head screw is removed the battery box cover can be taken off providing access to the battery. The battery can then be removed from its connections and a new battery can be installed and the cover replaced. The battery required is a 9volt DC PP3 (mn1604) or equivalent. **NB.** The use of rechargeable batteries is not recommended.



2.5 ENGAGEMENT OF THE ROLLERS ONTO THE TYRES

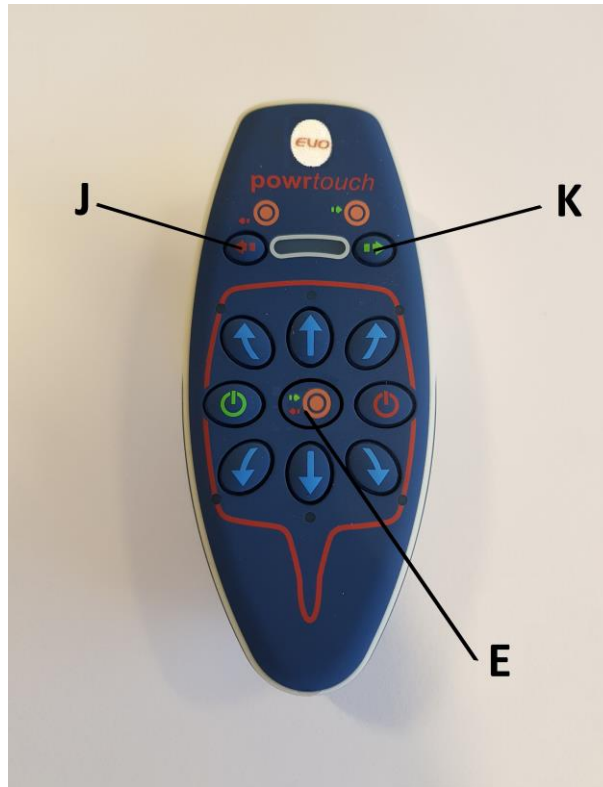

NB. If the actuators have been started by accident and need to be stopped immediately then press either of the 'On' buttons (D or F), see Emergency Switch Off - See Section 1 Paragraph 1.2.

With both the Powrtouch isolation switch and handset switched on then: -

1. Press and hold the 'Function' button (E)
2. Press the 'Roller Engagement' button (K) and then immediately release BOTH E and K buttons
3. The LEDs in the indicator window will scroll to the right. All 4 green LEDs will then flash as the mover is finalising its engagement cycle.
4. Always check that **BOTH** rollers are fully engaged on to the tyres of the caravan before removing the handbrake. This can be done visually by checking the yellow Roller Position Indicator is located in the correct position as shown below.
5. Always ensure that both sides have fully engaged before moving the caravan.

NOTE: DO NOT TURN OFF THE RED ISOLATOR KEY UNTIL THE MOVER HAS FULLY PARKED I.E ALL 4 GREEN LIGHTS HAVE STOPPED FLASHING.

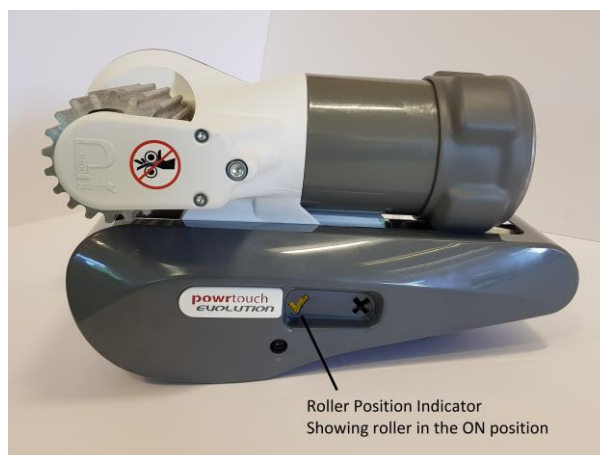

Once the Rollers are engaged **ONLY** then disengage the handbrake when you are ready to use the Powrtouch Evolution.

2.6 MOVING THE CARAVAN (HANDSET OPERATION)

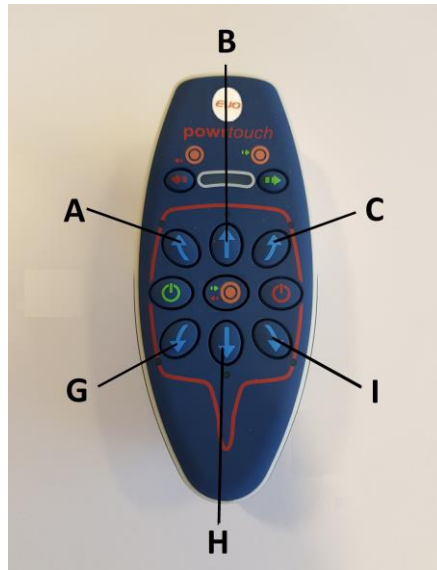

The caravan can be moved as required by pressing buttons A, B, C, G, H or I. The caravan will move in the direction of the arrows printed on these buttons. The Electronics Control System also has a continuous movement capability in that if button B is being pressed then buttons A or C can be used, alternatively if button H is pressed then buttons G or I can be used, using this sequence will allow the Powrtouch to redirect the caravan without stopping the forward or backward motion. Note: On AWD units only pressing opposite buttons (i.e A & I or C & G) will enable a quick turn function by stopping the wheels from turning on the inner arc of the turn.

Please note that the speed settings will always default to MAXIMUM – Speed changes can only be made when the caravan is stationary

2.7 DECREASING AND INCREASING SPEED

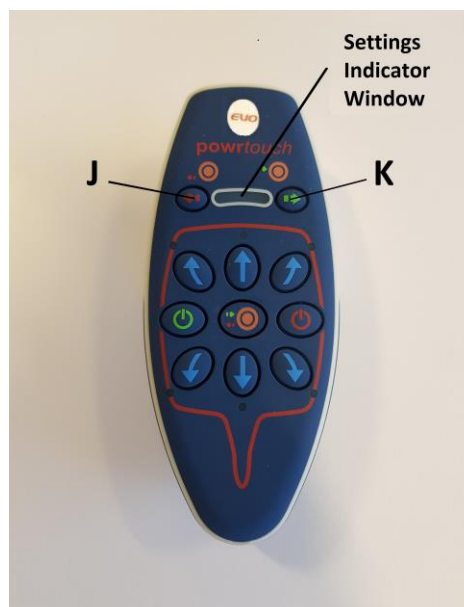

When the handset is first switched on the settings indicator window will always show an illuminated green LED to the extreme right-hand side of the window and this is the default position of maximum speed (100%). The speed can be decreased by pressing the 'Speed Decrease' button (J), each time this button is pressed the speed will decrease by 25% and the green LED will move from left to right in the window to indicate the speed setting selected. **NB.** The minimum speed setting is 25%. As the speed decreases the torque decreases in the same ratio i.e. 50% speed is 50% torque. This function of using a slow speed with lower torque setting is designed to maintain the caravan/trailer's manoeuvrability in very restricted and/or confined spaces.

If the Powrtouch is not at its maximum speed, then the speed can be increased in 25% increments by pressing the 'Speed Increase' button (K). When changing the speed of the Powrtouch, the illuminated green LED will move (a maximum four stages) from the left to the right in the window; when the LED is positioned at the extreme right of the display this indicates the Powrtouch has returned to the maximum speed setting. The speed can only be changed when the caravan is not moving.

2.8 PRECISION CONTROL OF THE CARAVAN USING THE ELECTRONIC SOFT START FUNCTION

By utilising its very effective Electronic Soft Start System the Powrtouch Evolution can easily move the caravan a distance of 1mm at a time. This small movement can be achieved by pressing and quickly releasing a direction button (stabbing the button), this facility makes attaching the caravan to the tow ball of the car a very simple operation. Reducing the speed will also give greater control of the caravan when using the soft start in this way. It is recommended that a good practice session should be carried out on level ground and in an open space before any difficult manoeuvres are undertaken.

2.9 RETRACTION OF THE ROLLERS FROM THE TYRES

**ALWAYS ENSURE THE CARAVAN/TRAILER HANDBRAKE IS ON BEFORE
DISENGAGING THE ROLLERS FROM THE TYRES**

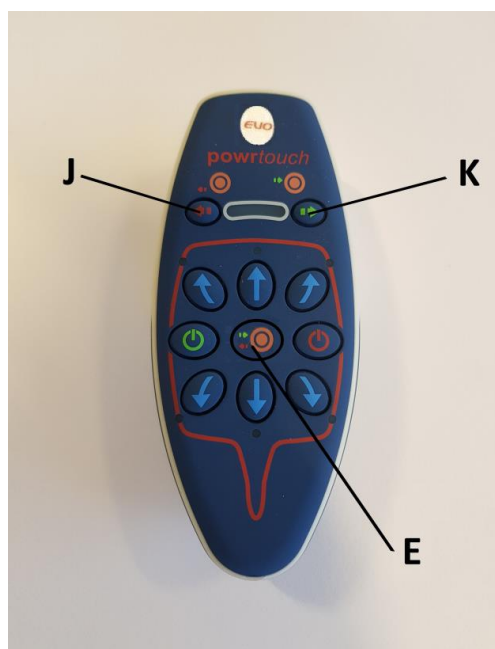

NB. If the actuators have been started by accident and need to be stopped immediately then press either of the 'On/Emergency Stop' buttons (D or F), see Emergency Switch Off - See Section 1 Paragraph 1.2.

With both the Powrtouch isolation switch and the handset switched on then: -

1. Press and hold the 'Function' button (E)
2. Whilst holding button E press the 'Roller Disengagement' button (J) and then immediately release BOTH E and J buttons
3. The lights in the indicator window will scroll to the left. All the green LEDs will then flash as the mover is finalising its disengagement cycle.
4. Always check that **BOTH** rollers are fully disengaged from the tyres of the caravan/trailer before attempting to drive away. This can be done visually by checking the yellow Roller Position Indicator located in the correct position as shown below.

NOTE: DO NOT TURN OFF THE RED ISOLATOR KEY UNTIL THE MOVER HAS FULLY PARKED. I.E ALL 4 GREEN LIGHTS HAVE STOPPED FLASHING.

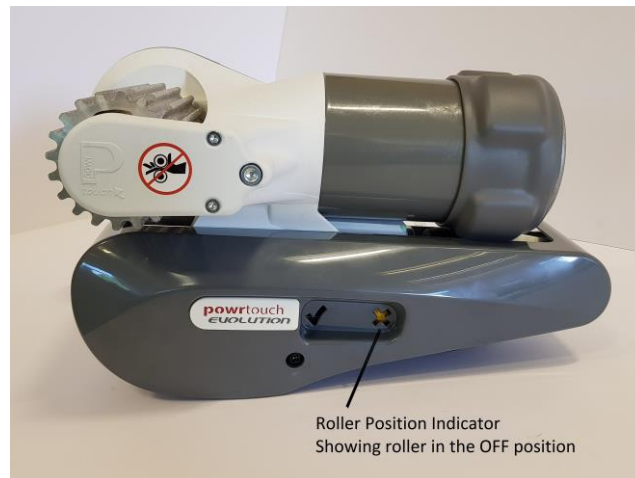

NB. The rollers can be removed manually from the tyres in the unlikely event that they do not retract electrically. (e.g. flat battery) To do this:

1. Switch off the isolation switch by turning the key anti-clockwise and removing.
2. Remove the end bung (shown in the picture below).
3. Insert the manual removal tool (T Bar) and turn 30 times anti-clockwise.
4. **If in doubt consult a qualified Powrtouch Engineer.**



2.10 SWITCHING OFF THE UNIT

The handset does not need to be turned off manually except in the case of an emergency (See Section 1 Paragraph 1.2). If the handset is left unused for 3 mins approximately it will automatically turn itself off. However, once you have finished using the Powrtouch Evolution caravan mover, ensure the unit is switched OFF with the isolation switch and the key is removed.

2.11 MAPPING (Tuning/Coding) INSTRUCTIONS – Given for Information ONLY

All electronics systems are supplied with the handset mapped (tuned/coded) to the ECB, should you require to map or remap the system the sequence is as follows: Using the plastic needle provided (attached under the hinged lid of the ECB) press the remap button through the small hole (labelled 'R') in the lid of the box, this enables the control board to search for a signal. Then switch on the handset, and it will transmit a welcome mapping signal to the control board and the system will automatically code **(this must be done on BOTH electronics for the All Wheel Drive (AWD) System.**

2.12 FITTING AND REMOVAL OF THE SIDE COVERS



To fit the side-cover insert the three lugs on the side-cover into the three holes on the metalwork as shown in the picture above. Push the side-cover until the lugs click in place. Secure the side-cover with the retaining screw. Insert the retaining screw into the screw hole as shown in the picture above. Do not over-tighten the screw.

To remove the side-cover unscrew the retaining screw until free and pull the cover directly toward you.

SECTION 3 – DIY FITTING INSTRUCTIONS

3.1 RECEIVING YOUR POWRTOUCH EVOLUTION

When unpacking the box there is a checklist of the components of the mover. Please check that all parts have been received before commencing the installation work (See Fig 2 showing component parts). If in doubt please contact a qualified Powrtouch Engineer. Contact details are on the front page of this document.

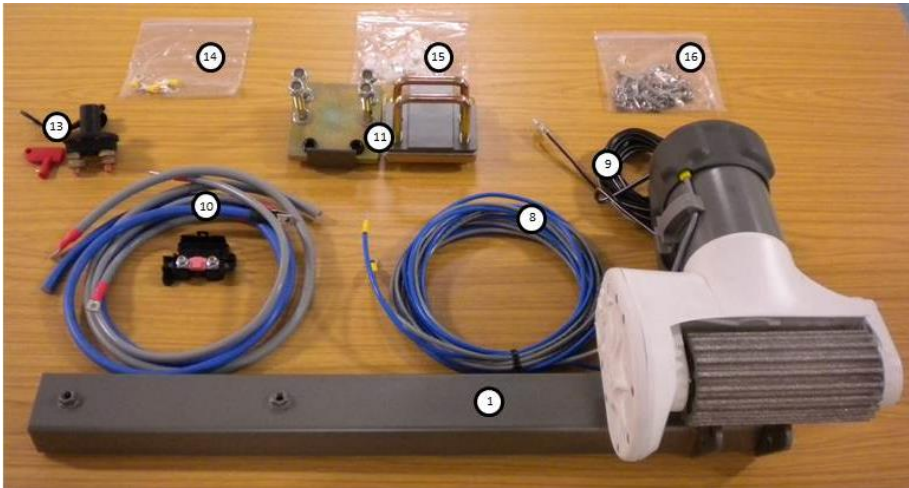

Key To Parts

- 1 – Left Hand Unit
- 2 – Right Hand Unit
- 3 – Electronics Control Box (ECB)
- 6 – Handset Lanyard
- 7 – Manual Removal Tool (T Bar)
- 8 – Motor Wires
- 9 – Actuator Wires
- 10 – Battery Wire Set with Fuse
- 11 – Clamp Set
- 12 – Stop Blocks
- 13 – Isolator Switch with Key
- 14 – Spare Motor Crimps
- 15 – P Clips
- 16 – Screw Set
- Centre Bar (not shown)
- Side Covers
- Electronics Handset

NB. An All Wheel Drive Evolution (AWD) will include a further axle set (Parts 1,2,3,8,9,11,12,14,15,16 Centre Bar & Side Covers).



Fig 2. Pictures Showing Component Parts

3.2 TOOLING AND EQUIPMENT REQUIRED

To install the Powrtouch the following tooling and equipment will be required (not supplied):

- 10mm Socket & Ring Spanner
- 13mm Socket & Ring Spanner
- 17mm Socket & Ring Spanner
- Power Drill with 3mm & 10 mm Drill Bits suitable for wood
- 25mm Hole Saw for Plastic (for fitting isolation switch)
- 16mm Hole Saw for Plastic (for self-adhesive seals)
- Various Screwdrivers
- Multi Purpose Silicon Sealant
- Lighting as necessary
- Trolley Jack or Axle Stands (for raising unit into position)
- Support Blocks, Wheel Chocks for Safety (to ensure the caravan cannot move during the fitting operation)
- 8mm Allen Key
- Torque Wrench
- Safety Goggles

3.3 INSTALLING THE POWRTOUCH EVOLUTION

NB. VERY IMPORTANT: BEFORE COMMENCING, PLEASE ENSURE THAT THE CARAVAN IS DISCONNECTED FROM IT'S 12 VOLT D.C. LEISURE BATTERY SUPPLY AND ANY OTHER ELECTRICAL SUPPLIES (INCLUDING 240 VOLT MAINS).

All electronic and electrical controls of the system are carried out by the Electronics Control Box (ECB) and isolation switch; please note the ECB has an inbuilt safety thermal fuse (set at 90 deg C). Should this fuse operate it will automatically reset itself when the system cools to an acceptable temperature.

The Isolation Switch must be accessible at all times when parking and moving the caravan/trailer, please be aware of this when selecting the location for the switch (See Section 3 Paragraph 3.8).

Please check that the tyres are of the same size and design (preferably from the same manufacturer) and not over worn (fitting to new or nearly new tyres is the best option). It should be noted that as the caravan tyres wear, the roller to tyre gap will increase, this could allow the Powrtouch rollers to slip when driving the tyres, should this occur, the Powrtouch will require adjustment. Also ensure the tyre pressures are correct to the manufacturer's recommendation prior to commencing the fitting of a Powrtouch. Also check that the chassis is in good condition without any damage and free from rust or corrosion etc.

Ensure that the handbrake is in the ON position before the caravan is raised using the front steadies and Jockey Post/Wheel, the back steadies are then lowered to make sure the caravan is fully stabilised and no forward or backward movement can occur.

All work MUST be carried out to ensure personal safety

3.4 CHECKING THE CHASSIS DEPTH

All models of the Powrtouch Evolution are designed to fit on standard chassis depths of either 150mm or 200mm approximately.

3.5 SPECIAL MOUNTING PLATES

On some recently manufactured caravans (in particular Hymer) special mounting plates may be required. These plates can be supplied (for a small additional cost) and are fitted by nuts and bolts using pre-drilled holes in the chassis. Once these plates are fitted then the mechanical assembly of the unit will proceed as detailed below.

3.6 MECHANICAL ASSEMBLY

For safety reasons it is recommended that the fitting of the Powrtouch Evolution should be undertaken on a flat hard standing. Before raising the caravan, ensure the handbrake is on and then it can be raised as required (using trolley jack and/or axle stands) and secured in position using the caravan steadying legs with supporting blocks and wheel wedges as necessary; it is then helpful to lay down a ground sheet. Remove all items from the packaging onto the protective sheet. Ensure both rollers are in the DISENGAGED position, as the unit will not fit correctly otherwise. Loosely assemble the left-hand motor unit, right hand motor unit and alignment tube and place under the caravan/trailer.

Wherever possible the Twin Axle Powrtouch Evolution should be fitted behind the rear of the rear axle. If this is not possible then it is acceptable to fit the unit in front of the front axle. An AWD Evolution will be fitted both behind the rear axle and in front of the front axle.

Using appropriate support blocks raise the loosely assembled unit into an approximate position, fit the clamps and U-Bolts (see Fig 3) to the chassis (do not tighten at this point). Adjust to the correct place using the 19mm wooden spacer provided between the tyre and the drive roller (on each side of the trailer). Please note the wood spacer blocks should be a sliding fit between the tyre and the coarse drive roller.

Also adjust the position of the drive rollers in relation to the tyres by sliding the motor units on the alignment tube until the maximum amount of roller is in contact with the tyre tread without any part of the unit fouling the tyre or chassis. It is advisable to leave a minimum 10mm gap between the Powrtouch Evolution unit and the inside wall of the tyre, this is to allow for the expansion of the tyre when the rollers are engaged. Before tightening the u bolts to the recommended 35 ft lbs tighten the alignment tube pinch bolts and lock nuts making sure the alignment tube is approximately centralised; it is then advisable to check the roller / tyre gaps again. The assembly should then be secured by tightening the U-bolts to the recommended torque of 35 ft lbs using a torque wrench.

Check both the above alignments at least once during the process and on completion.

Once the motor assemblies are completed the stop blocks should now be fitted on the chassis in a position directly behind the Powrtouch clamping plates to ensure that the motor assemblies do not slide along the chassis away from the tyres when the drive rollers are engaged to the tyres (see Fig. 3). Once correctly positioned they can be tightened using the locking bolt and nut with a torque wrench spanner set at 35 ft lbs.

FIG 3: CLAMP ASSEMBLY WITH STOP BLOCK

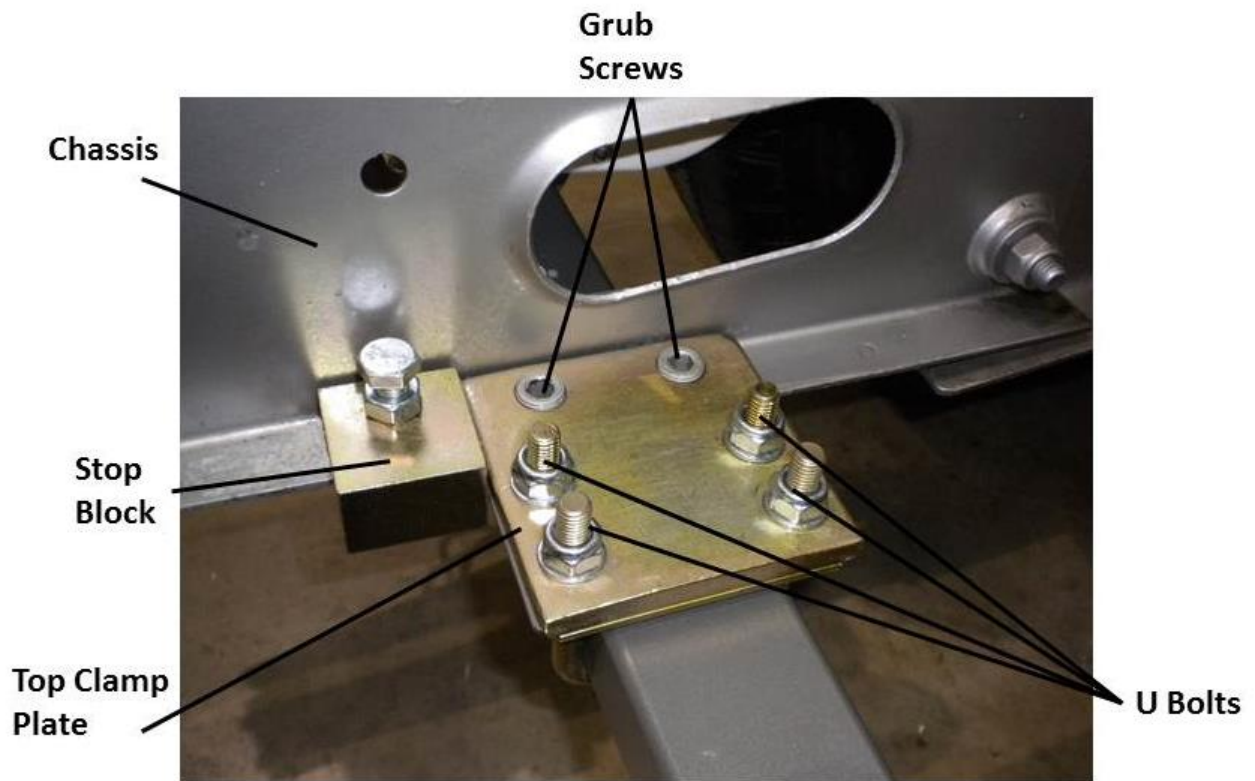

3.7 ELECTRICAL ASSEMBLY

AGAIN - PLEASE ENSURE THAT THE BATTERY AND MAINS LEAD ARE BOTH DISCONNECTED FROM THE CARAVAN BEFORE COMMENCING INSTALLATION

NB. The terms right hand (UK Nearside) and left hand (UK Offside) referred to on the electronics control box are determined by standing in front of the caravan (at the hitch) facing the caravan. Twin axle contains one ECB, the AWD contains two ECBs.

The recommended site for the Electronics Control Box/Boxes (ECB) is inside the caravan in the dry (bedding) locker behind the battery box. The ECB should be screwed to the floor using the screws provided. **Please note some caravans have under floor cables and/or pipes, checks must be made to ensure it is safe to drill.** If safe to do so then drill four 10mm diameter holes in the floor approximately 150mm from the control box for the motor wires to be fed into the caravan. Start routing the wires from the motor, remembering to leave a small amount of slack cable near the motors to allow for their movement when the drive rollers are engaged. The motor wires (two each) and Powractor wires (if fitted) can now be routed along the underside of the caravan floor using the P clips provided (securing of the cables can be made with a suitable staple gun and the correct size staples – not provided). Care should be taken to ensure that the cabling is securely fitted so that no chafing can occur and that it does not sag. Also ensure cables do not make contact with the steel chassis (unless suitable cable clips are used – not provided). If the Powrtouch is fitted in front of the wheels, then the ECB should be wired as shown below. The Powractor Motors should be wired as shown in Fig 6F.

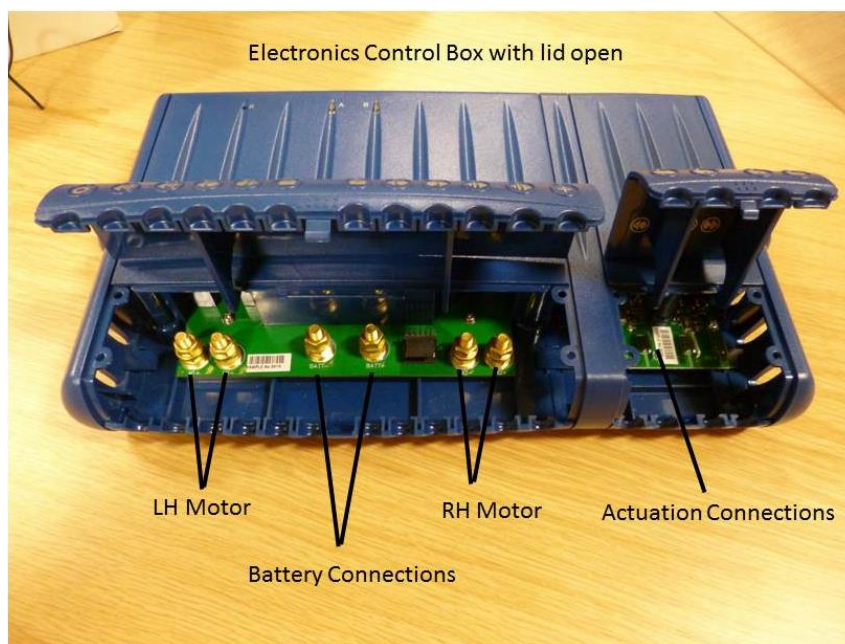

Should the Powrtouch Evolution be fitted behind the wheels then the polarity of the motor (only) wires should be reversed from the positions shown in Fig 6A1/2.

Twin / AWD Wiring Diagram – Front Axle

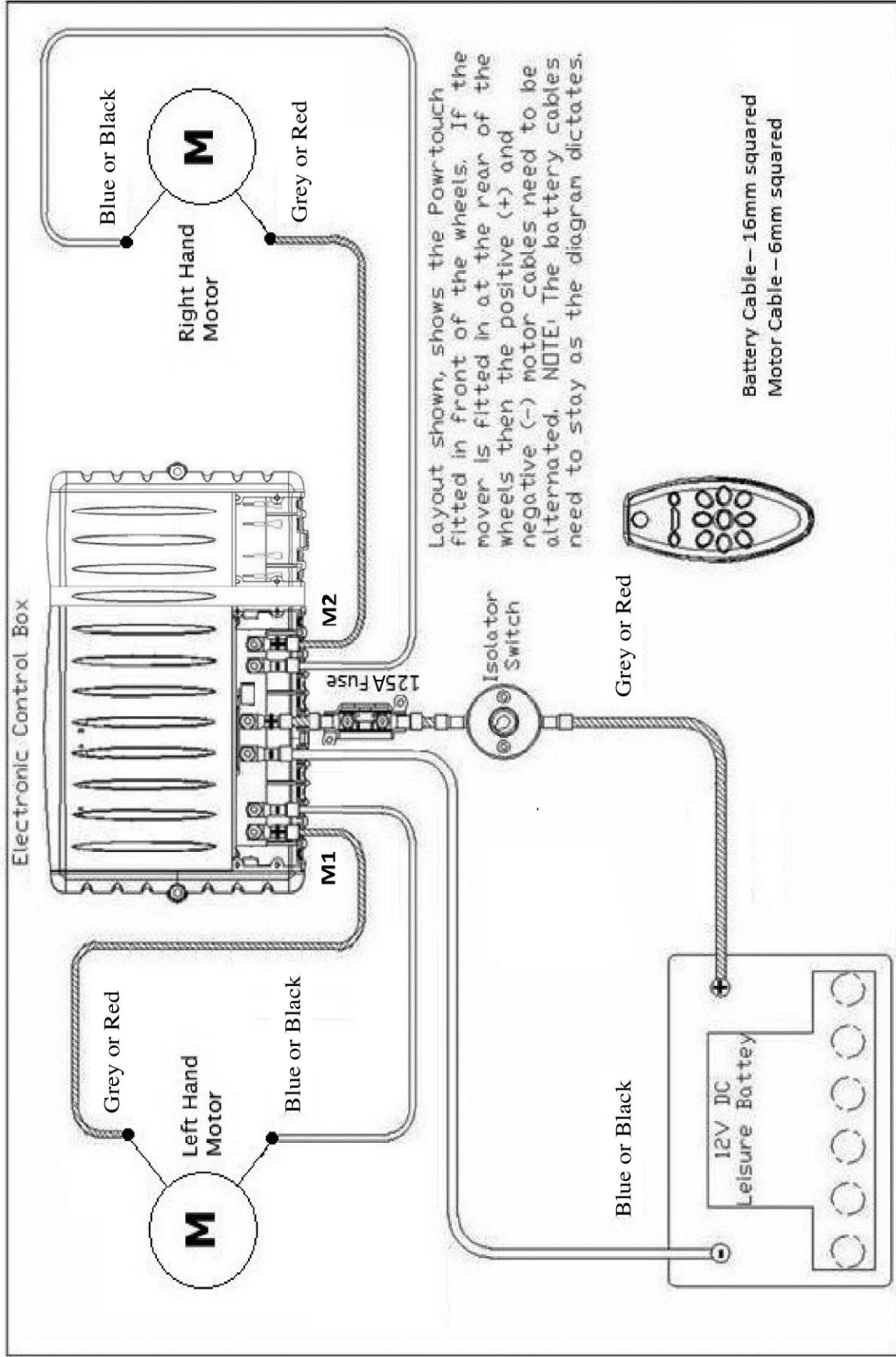

Fig 6A1. Electrical schematic diagram

Twin / AWD Wiring Diagram – Rear Axle

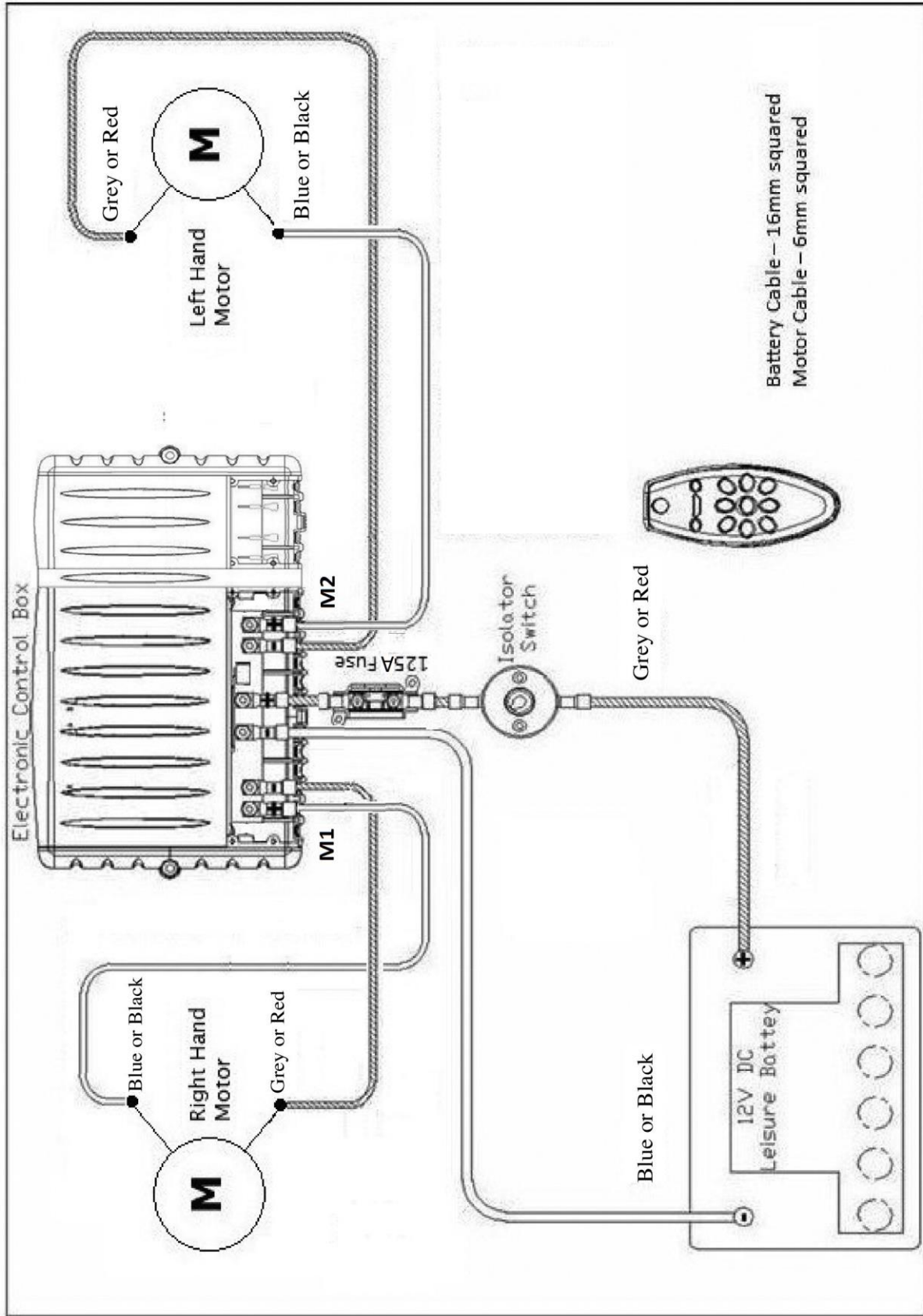
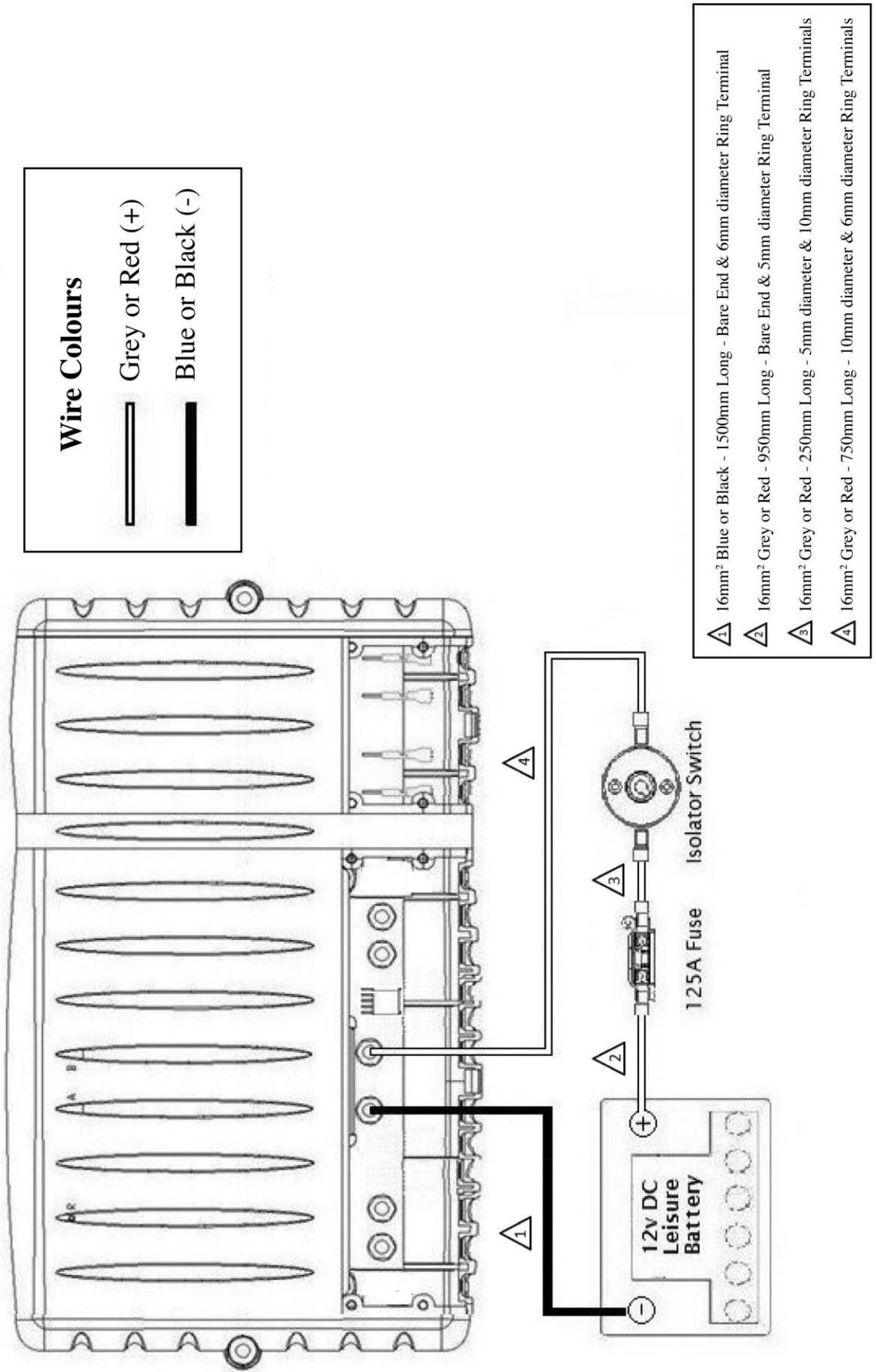
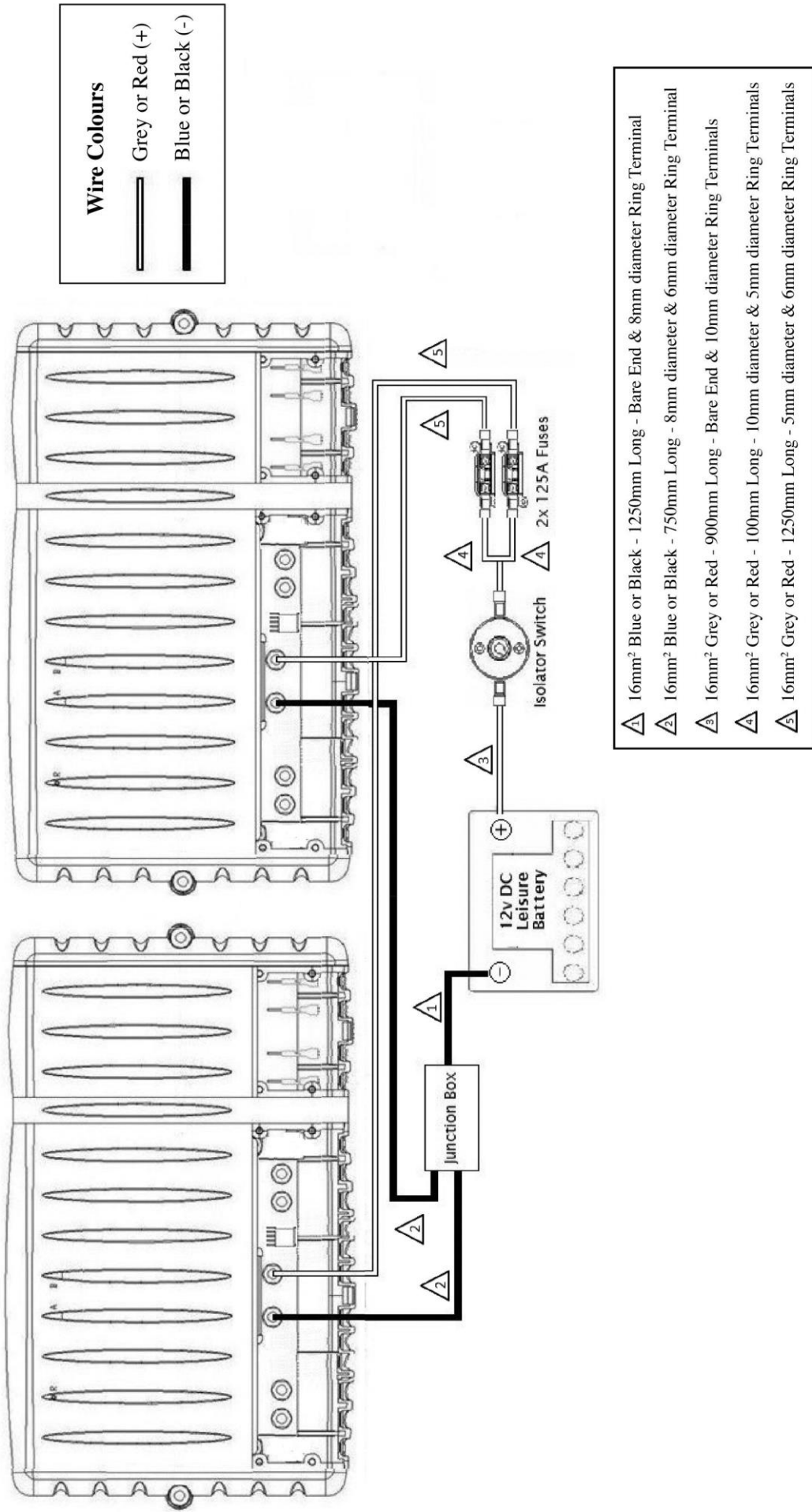

Fig 6A2. Electrical schematic diagram

Twin Axle Battery Wiring Diagram – Fig 6A3



AWD Battery Wiring Diagram – Fig 6A4



Electronic Control Box with Actuator

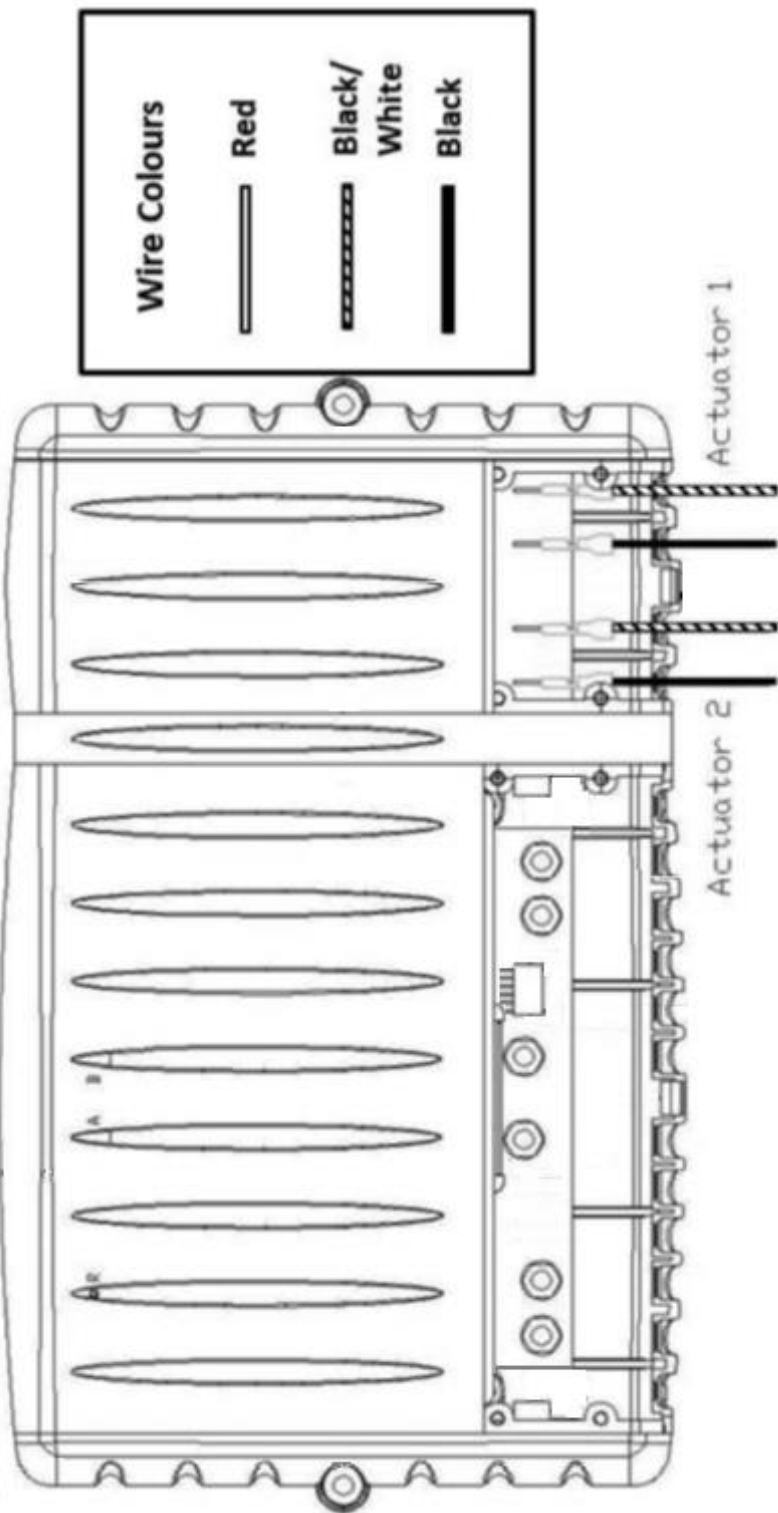

Fig 6F. Electrical schematic diagram - Powrtouch Evolution Actuators

Any excess motor cable should then be coiled up (secure with cable ties as necessary) in a convenient position inside the caravan/trailer. When coiling the motor cables please ensure that the coils are kept as far away from the electronics box and aerial as possible. It is recommended that motor cables should **NOT** be cut to ensure that: -

- 1) They are of equal length
- 2) Should the Powrtouch Evolution be removed and refitted to a new or different caravan then the cables can easily be reused.

Please ensure the battery is in good condition (See Section 5 Paragraph 5.4), a fully charged **leisure** battery **MUST** be used and can be either a lead acid or gel type (**Please note that car batteries are not suitable to operate Powrtouch Movers.**) A 110-Ampere hour battery is recommended for optimum operation of the Powrtouch Evolution. Smaller batteries may be utilised, but mover performance may be reduced. The aerial (thin black cable) should be let through the caravan/trailer floor directly next to the ECB (drill a small 3mm hole as required) and then run in a straight line away from the ECB and all motor cables. The aerial should be clipped in place with the last 25mm (1 ins.) of the cable left dangling down. Under no circumstances should the length of the aerial be changed either by cutting or extending by splicing into it.

3.8 CONNECTING TO THE CARAVAN BATTERY

Please be aware of the need for access to the isolation switch when parking your caravan/trailer. The switch should also be fitted to be in an accessible position whilst the unit is in operation.

The Powrtouch is supplied with an inline switch which allows the isolation of the electrical control box from the Battery. The suggested location for the fitting of this switch is in the sealed side compartment within the battery box (**see NOTE below**), usually beneath the 240-volt mains connector. The reason for this location is to ensure that the Powrtouch isolation key will obstruct the use of the 240-volt AC mains connector; under no circumstances should the Powrtouch be operated while the caravan is connected to the 240-volt AC supply. Drill a 25mm hole with the hole-saw and the two 5mm clearance holes for the fixing nuts and bolts, when the holes are drilled install the switch and tighten up the nuts and bolts.

The electronics control box, isolation switch and the in-line fuse MUST NOT be located in the battery box or any compartments containing gas bottles. This is due to risk of explosion caused by leaking gas and a spark generated by the electronics, isolation switch or fuse.

The 16mm² battery cables are provided correctly terminated for their application and the length of these cables must not be altered in any way. The 1500mm Blue or Black (negative) battery cable is connected directly from the negative terminal of the caravan battery to the negative terminal of the ECB. **NB.** Starting from the non-terminated (bare end) 950mm of this cable is double insulated, this part of the cable must be connected to the battery. The 1000mm Grey or Red (positive) battery cable is all double insulated. This cable is used to connect the positive terminal of the battery (bare end) to one terminal of the inline fuse positioned in the caravan. This fuse is provided to protect the ECB from overload or misuse. The battery cables have to pass through 16mm dia. drilled holes in the battery box to gain access to the caravan. These cables should be protected from chafing and the battery box sealed from leaking gas by the use of self-adhesive seals (supplied). These seals **MUST** be fitted. The 250mm Grey or Red (positive) battery cable connects the free terminal of the inline fuse to a terminal of the isolation switch. The 750mm Grey or Red (positive) cable then connects the second terminal of the isolation switch to the positive connection on the ECB. Once connected these cables will then need to be securely fitted using the 'P' clips provided.

When making the connections to the battery it is recommended that connections are made to the electronics and isolator switch before connecting to the battery. Please ensure that their polarities are correct (Grey or Red Cables to Positive and Blue or Black Cables to Negative). Should they be connected incorrectly then this will result in damage to the electronics box.

- 1) Drill two 16mm dia holes (making sure that BOTH seals will not overlap).
- 2) Clean surface with methylated spirits or similar.
- 3) Push the self-adhesive seal onto the shank end of a 10mm dia drill bit then remove paper backing.



- 4) Locate the self-adhesive seal over the drilled 16mm dia hole; the 10mm dia drill bit will help to keep the seal central over the 16mm hole. Push firmly to the battery box surface.



- 5) Pull drill bit away.



- 6) Push cable through the self-adhesive seal.



All remaining cables can then be connected to the ECB ensuring that they are fitted in accordance with Fig 6A1/2 and Fig 6F. The electrical assembly is now complete. Check the roller rotation corresponds to the handset controls and the actuators function correctly. Any hole(s) drilled for motor wires to access the caravan should now be sealed with the silicon sealant to prevent ingress of damp or water. The Powrtouch Evolution side covers can now be fitted by securely pushing into place.

AWD REF FIG 6A4

The 16mm² battery cables are provided correctly terminated for their application and the length of these cables must not be altered in any way. The 1250mm Blue or Black (negative) battery cable is connected to a junction box (provided). **NB.** Starting from the non-terminated (bare end) 950mm of this cable is double insulated and fitted with a self-adhesive seal; this part of the cable must be connected to the battery. The two 750mm Blue or Black (negative) cables are connected to the free junction box post and then one to each ECB. The 900mm Grey or Red double insulated (positive) cable then connects the battery to the isolator switch. The battery cables have to pass through 16mm dia drilled holes in the battery box to gain access to the caravan. These cables should be protected from chafing and the battery box sealed from leaking gas by the use of self-adhesive seals (supplied). These seals **MUST** be fitted. The two 100mm Grey or Red (positive) cables connect the free isolator switch terminal to the inline fuse holders (One wire per fuse holder). The fuse is provided to protect the ECB from overload or misuse. The two 1250mm Grey or Red (positive) Cables are then connected to the inline fuse holders and terminated at the positive battery connection at the ECB, as shown in Fig 6A4. Once connected these cables will then need to be securely fitted using the 'P' clips provided.

**If you are unsure about the installation consult a Qualified Powrtouch Engineer
Telephone: 01283 587900**

SECTION 4 – LOOKING AFTER YOUR POWRTOUCH

4.1 CLEANING THE POWRTOUCH EVOLUTION

It is recommended that after your Powrtouch Evolution has been fitted the mechanical assembly would benefit from being sprayed with a light coating of wax oil (this could be repeated on an annual basis) by doing this you will be giving the mover better protection from water and rust and potentially prolonging its life well beyond its full 5-year guarantee. If necessary, it can be washed with clean water but under no circumstance should a pressure washer be used on a Powrtouch Evolution system. We recommend that your Powrtouch is cleaned, and lubricated with a motorcycle chain lubricant, or similar, once every 5 – 6 months. Please refer to our website support pages for instructions.

4.2 CLEANING THE ROLLERS

Ensure that the rollers are kept clean; this can be undertaken by washing with a hard brush. **For safety reasons it is recommended that the isolation switch is turned off and the key removed prior to cleaning the rollers.**

Also check that no stones or other debris are trapped in any part of the mechanism.

SECTION 5 – GUARANTEE & FAULT FINDING

5.1 GUARANTEE

A **NEW** Powrtouch Evolution is covered by a **FIVE YEAR** no quibble parts and labour guarantee. **NB. IT IS AT THE COMPANY'S DISCRETION WHETHER THIS GUARANTEE IS TRANSFERABLE TO A SECOND OWNER, AND A CHARGE WILL BE MADE FOR ANY AGREED TRANSFER. PLEASE CONTACT POWRTOUCH SALES TEAM FOR FURTHER INFORMATION.**

NB. Our guarantee covers reasonable use of the mover, it does **NOT** cover damage caused by misuse. The guarantee cannot cover any malfunction caused by the fitting of the mover if the fitting has been done on a DIY basis or purchased from/fitted by a non-approved dealer or agent. Any unauthorised modifications, use of non-original Powrtouch spare parts or failure to respect the installation or operating instructions will render this guarantee null and void. Powrtouch reserve the right to make a call out and/or repair charge for any work required to be undertaken to rectify faults that are outside of the company's control, e.g. **caravan battery failure**, incorrect or poor fitting, misuse, accidental damage etc.

5.2 REPORTING A FAULT

ALWAYS ENSURE THAT YOUR BATTERY IS FULLY CHARGED AND IF YOU ARE IN DOUBT ABOUT BATTERY STATUS USING THE BATTERY GAUGE ON YOUR CARAVAN CHECK WITH THE VOLTAGE CHART SECTION 5 PARAGRAPH 5.4

PLEASE PAY SPECIAL ATTENTION TO TESTING THE BATTERY UNDER LOAD.

TO CARRY OUT THESE CHECKS THE CARAVAN MUST BE DISCONNECTED FROM ITS 240 VOLT SUPPLY.

Before you call Powrtouch to report a fault you should have the serial number of your Powrtouch available, as you will be asked for this information. It allows a Powrtouch Engineer to locate the full manufacturing status of the mover and be able to advise you accordingly.

Also, before reporting a fault you are requested to check through the fault-finding list Section 5 Paragraph 5.5 to see if any of them can solve the problem. Failure to comply to this may result in you be asked to carry out some of these tests, thus delaying action to repair if required.

5.3 ELECTRONICS CONTROL BOX - LED STATUS

LED Status Array in Use	Red Light	Green Light	
Power Up Normal	OFF	ON	
Incoming Data Transmission	ON	ON	
Awaiting Configuration	FLASH	FLASH	Alternating
LED Status Array - Fault Diagnosis			
PCB Over Heat	FLASH		
Low Caravan Battery Voltage		FLASH	
Over Current on MOSFET Drive	FLASH	FLASH	Together

5.4 CHECKING THE CHARGE STATUS OF A 12 VOLT BATTERY

APPROX CHARGE STATE	VOLTMETER READING (No Load)	HYDROMETER READING
100%	12.7 v or over	1.27
75%	12.5 v	1.23
50%	12.4 v	1.20
25%	12.2 v	1.17
Discharged	12.0 v	1.10

Please Note: Voltage readings should be taken at least 4 hours (and could be up to 12 hours depending upon charging rates) after recharging to obtain an accurate reading.

The above figures are for the battery when under no load, if a battery is on the point of failing or not fully charged then the only test that will determine this is to take the readings under load (drop test). This can be achieved by using the Powrtouch mover with the rollers engaged to the tyres and driving both rollers forwards or backwards, if the reading drops to 12 volts or less the safety cut out on the ECB will stop the Powrtouch to prevent damage to the battery. However, this is an indication of insufficient battery voltage to drive the Powrtouch caused by an under charged or failing battery. PLEASE BEAR SAFETY IN MIND AND THAT BEING IN THE CARAVAN WATCHING THE METER YOU DO NOT DAMAGE THE CARAVAN BY RUNNING INTO AN OBSTRUCTION.

The above voltages are accurate at 25 degrees centigrade. In temperatures less than this the battery performance and output decreases by 1.25% per degree.

5.5 FAULT FINDING CHART

Symptom of Fault	Possible Fault and Method of Correction
Unit fails to operate	Reset the ECB by turning off the isolation switch and removing the key for at least 20 seconds and then turning on again. The green light on the ECB should be illuminated.
Unit fails to operate – seems completely dead – Red Light flashing on ECB	Over heating - remove isolation key and leave 20 minutes to see if the thermal fuse will reset itself, RED LIGHT WILL STOP FLASHING and the ECB should not feel hot.
Unit fails to operate – seems completely dead	Check that the green light is illuminated on the electronics, if not check that the in-line fuse is not broken and 12volts DC is getting to the ECB.
Unit fails to operate or operates intermittently	Check the battery voltage of the handset is correct at 9.5 volts. If the 2 rows of Red LED's flash, then this is a sign the handset battery is low.
Unit fails to engage on one side (auto mover only)	Ensure that both sides have fully disengaged before turning off the mover. Using the supplied T bar wind clockwise by 2 turns. The mover should then auto engage again when using the remote control. ALWAYS ENSURE THE MOVER HAS FULLY PARKED AND LIGHTS ON HANDSET HAVE STOPPED FLASHING BEFORE TURNING OFF YOUR ISOLATOR SWITCH
Unit fails to operate or moves intermittently	Badly connected or corroded battery terminals, check battery terminals are clean and connected as required.
Unit fails to operate or moves intermittently – Green light flashing on ECB	Caravan battery low - check voltage of battery (see battery voltages chart Section 5 Paragraph 5.4). Charge or renew caravan battery.
Caravan fails to move or moves intermittently	Caravan battery low - with the rollers engaged move the caravan and check the voltage drop on the caravan battery meter. If this drops below 12 volts, it is advisable to have the battery tested by an accredited supplier, then as necessary charge or renew caravan battery.
Roller will not disengage auto operation	See Section 2 Paragraph 2.9 Retraction of the Rollers from the tyres.
Rollers slip on wheels	Disengage rollers from the tyres and the gap should be 19mm approx. Also check the tyre treads are not badly worn and the tyre pressures are correct.
IF IN DOUBT CONSULT A POWRTOUCH ENGINEER - TEL: 01283 587900	

ADDITIONAL INFORMATION TO NOTE

1. To the best of our knowledge these instructions were accurate at the date of publication.
2. Wherever the Powrtouch Evolution is fitted this should be done in accordance with the local standards applicable to the installation of a remote-controlled caravan moving system.

Truma Limited

Powrtouch – A Truma Brand

2000 Park Lane, Dove Valley Park, Foston, South Derbyshire, DE65 5BG United Kingdom

TELEPHONE: +44 (0)1283 587900 **FAX:** +44 (0)1283 587910

WEBSITE: www.powrtouch.com **EMAIL:** info@powrtouch.com

TWITTER: www.twitter.com/powrtouchuk